

**10** YEARS  
OF UNIVERSITY  
RECOGNITION  
**20** YEARS OF  
ACADEMIC  
EXCELLENCE



**REVA**  
UNIVERSITY

Bengaluru, India

# REPORTS OF CLUB EVENTS / COMPETITIONS



Rukmini Knowledge Park  
Kattigenahalli, Yelahanka, Bengaluru – 560064  
[www.reva.edu.in](http://www.reva.edu.in)

**Club name: IoT Club**

**Date:** 29<sup>th</sup> Oct 2020

**Number of participants:** Outside of University.

**Activity Conducted:** Industrial Visit from Product team through UIIC to GILLS Instruments, Electronic City.

The School of CSA in association with UIIC, visited the GILLS Instruments, Electronic City, Bangalore, to explore the industry needs and to explore process of converting project to product and how innovations can be done were explored during the visit.

**Attendance: 8**

**Photographs:**



**DIRECTOR**  
School of Computer Science & Applications  
REVA University, Kattigenahalli,  
Bangalore - 560 064.

33

12 4

**Club name: IoT Club**

**Date:** 8<sup>th</sup> to 13<sup>th</sup> March 2021

**Number of participants:** 59

**Activity Conducted:** "IoT Boot Camp" for 6<sup>th</sup> B.Sc(R)

The objective of the program was to teach Internet of Things (IoT) & have the students develop some working models / projects on their own. Ethical byte Trainers provided greater value to students by providing them not only the most updated courses but also preparing them for taking online assessment exam that empower students to face the Interviews confidently during placements drives. The trainer also taught the best practices and latest techniques & tricks in coding. They also learned architecture & protocols, Arduino & Raspberry Pi, simulator, IoT Cloud & Security. The classes were conducted in the class rooms for 6 days (32 hours) and students had appeared for an assessment examination on the last day of the event. The outcome of the event was students learned how to develop projects such as , 3 factor authentication , Monitoring server , Satellite tracker , GPS tracker, Car dashboard etc .

**Attendance:**



**Photographs:**



*S. [Signature]*  
**DIRECTOR**  
School of Computer Science & Applications  
REVA University, Kattigenahalli,  
Bangalore - 560 064.



**Club name: IoT Club**

**Date:** 22<sup>nd</sup> to 27<sup>th</sup> March 2021

**Number of participants: 40**

**Activity Conducted: IoT Boot Camp**

The objective of the program was to teach Internet of Things (IoT) & make the students to develop some working models / projects on their own. Ethical byte Trainer provided greater value to students by providing them not only the most updated courses but also preparing them is taking online assessment exam that empower students to face Interview confidently during placements drive. The trainer also taught the best practices and latest techniques & tricks in coding. They also learned architecture & protocols, Arduino & Raspberry Pi, simulator, IoT Cloud & Security.

**Attendance:**

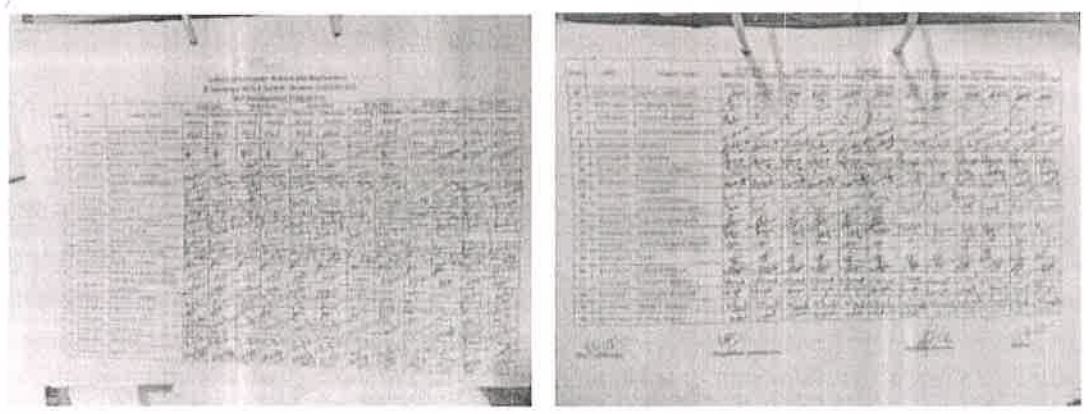

**Photographs:**

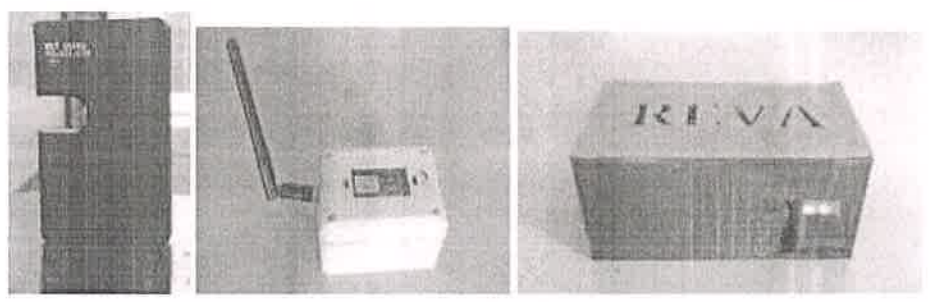

*S. D. [Signature]*

**DIRECTOR**  
School of Computer Science & Applications  
REVA University, Kattigenahalli,  
Bangalore - 560 064.



**Club name: IoT Club**

**Date:** 15<sup>th</sup> to 20<sup>th</sup> March 2021

**Number of participants: 41**

**Activity Conducted:** "IoT Boot Camp" for IV MCA A

The objective of the program was to teach Internet of Things (IoT) & make the students to develop some working models / projects on their own. Ethical byte Trainer provided greater value to students by providing them not only the most updated courses but also preparing them for taking online assessment exam that empower students to face interviews confidently during placements drive. The trainer also taught the best practices and latest techniques & tricks in coding. They also learned architecture & protocols, Arduino & Raspberry Pi, simulator, IoT Cloud & Security. The outcome of the event was students learned how to develop projects such as CRYPTO WALLET, Cost effective Repeater, Touchless Switches and gesture switches, Psychiatric light, Blind logger, Resist the resistor device, Power bank for LAPTOP, OXIMETER.

**Attendance:**

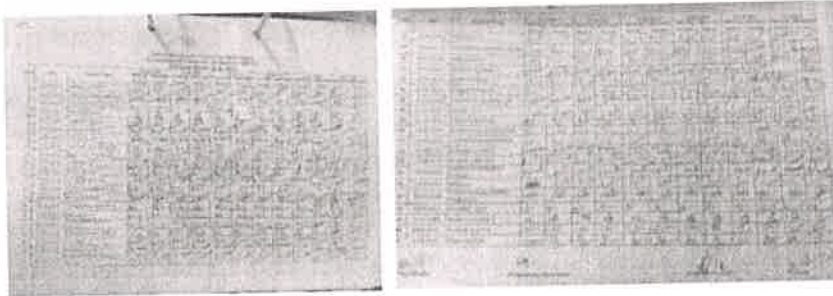

**Photographs:**

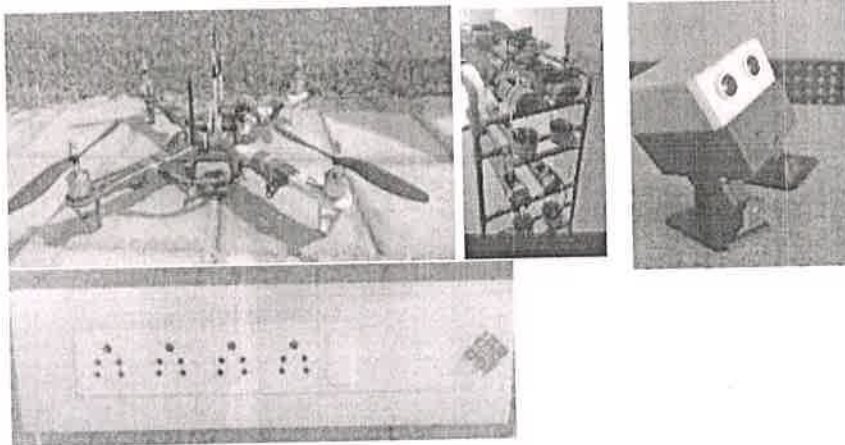

*S. Anu*

**DIRECTOR**  
School of Computer Science & Applications  
REVA University, Kattigenahalli,  
Bangalore - 560 064.

36

19<sup>6</sup>

**Club name: IoT Club**

**Date:** 29<sup>th</sup> May 2021

**Number of participants:** 400 students

**Activity Conducted:** Technical Seminar on “Cognitive IoT”

Webinar on Cognitive IoT was organized on 29<sup>th</sup> May 2021. The resource person was Dr. Pethuru Raj, Chief Architect and Vice President Jio Cloud Services Division Reliance Jio Platforms Ltd, Bengaluru, for students of all semester through MS Teams. The main purpose of the webinar was to enhance the skills of the student on IoT with cognitive technology. The students gained experience on how to work on IoT with cognitive technology and the way cognitive IoT improves the way of interaction with devices at a faster rate. Students learned about the importance of Cognitive IoT and how it can improve the transmission performance through establishing dynamic routing, searching optimal transmission path adaptively and optimizing configuration of each node in the network.

**Attendance:** Session was online, Link is attached. <https://bit.ly/3wC64Tg>

**Photographs:**



*S. [Signature]*

**DIRECTOR**  
School of Computer Science & Applications  
REVA University, Kattigenahalli,  
Bangalore - 560 064.



**Club name: Software and Coding Club**

**Date: 25.1.2021 to 30.6.2021**

**Number of participants: 13**

**Activity Conducted: Android App-Development –Alumni App**

Attendance List.

- 1) Pooja K J –IV.MS
- 2) Zeeshan IV MCA
- 3) Chaithanya –IV MCA
- 4) Athira – IV M.Sc
- 5) Bhoomika IV MCA
- 6) Rachel Negi BCA
- 7) Abhijeeth BCA
- 8) Sourajith BCA
- 9) Jai Surya BCA
- 10) Nagesh IV MCA
- 11) Vinay Kumar IV MCA
- 12) Sumanth IV MCA
- 13) Akash Roushan IV BCA

Photos of the app

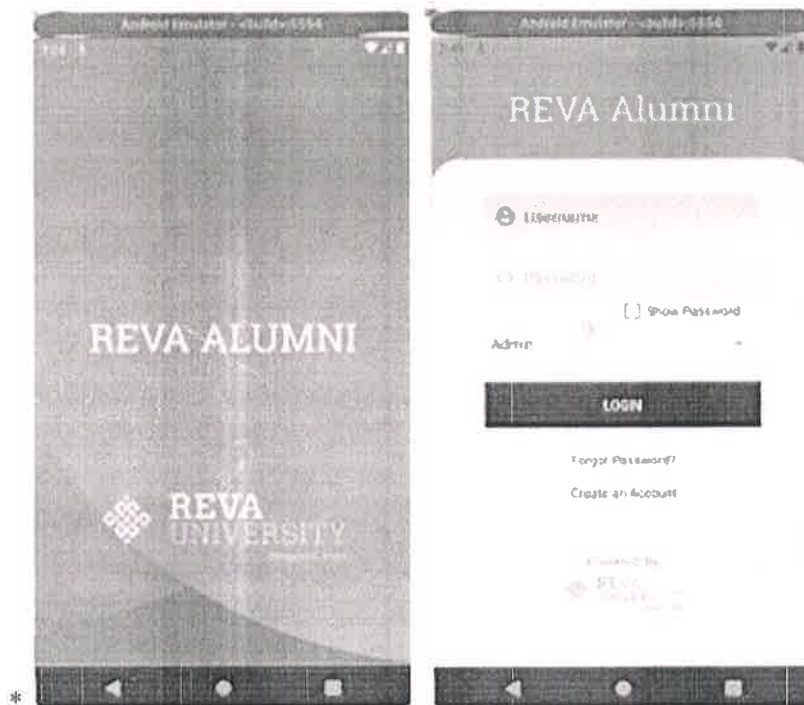

*S. D. S.*

**DIRECTOR**  
School of Computer Science & Applications  
REVA University, Kattigenahalli,  
Bangalore - 560 064.





**REVA**  
**UNIVERSITY**

Bengaluru, India

**SCHOOL OF COMPUTING AND INFORMATION TECHNOLOGY**  
**Organized 1 Day Hands-on Workshop**

**on**

**"Robotic Process Automation using UiPath Studio**

**DATE: 13-02-2021**

<b>About the Workshop</b>	<p>Robotic Process Automation is the technology that allows the automation of the task in exactly the way how a human does. A robot in robotic process automation does not mean that literally robots are going to replace human beings, but it means a computer program imitates human actions.</p> <p>In other words, we can say that RPA is a software program that imitates human actions while interacting with computer application and accomplishing the automation of repetitive and rule-based processes. RPA can be used to automate the labor intensive tasks such as back office processes, data entry, data validation etc.</p>
<b>Organized By</b>	School of Computing & Information Technology, REVA University.
<b>Date</b>	13-02-2021
<b>Convener</b>	<p>Dr. Sunil Kumar S. Manvi, Dean, Faculty of Engineering &amp; Technology, Director, School of CIT and CSE, REVA University.</p> <p>Dr. Mallikarjun M Kodabagi, Professor and Assistant Director, School of Computing and Information Technology, REVA University.</p>
<b>CO-ORDINATORS</b>	Prof. Surendra Babu K N, Prof. Aruna Kumara B, Prof. Gopinath R, Prof. Raghavendra Nayaka P
<b>Targeted Audience</b>	First Year students.
<b>Resource Persons</b>	<p>Prof. Surendra Babu K N Assistant Professor &amp; Director School of CIT, REVA University</p> <p>Prof. Aruna Kumara B Assistant Professor &amp; Director School of CIT, REVA University</p> <p>Prof. Nikhil S Tengli Assistant Professor &amp; Director School of CSE, REVA University</p> <p>Prof. Prabhuraj Assistant Professor &amp; Director</p>



	<p>School of CSE, REVA University</p> <p>Prof. Gopinath R Assistant Professor &amp; Director School of CIT, REVA University</p> <p>Prof. Raghavendra Nayaka P Assistant Professor &amp; Director School of CIT, REVA University</p>
<b>No. of Participants</b>	<b>23</b>

## Photographs during the Workshop

The poster is for a workshop organized by the School of Computing and Information Technology and the School of Computer Science and Engineering at REVA University. It is in association with the RPA Club and UiPath. The workshop is titled 'One Day Hands-on Workshop on Robotic Process Automation using UiPath Studio'. The date is 13<sup>th</sup> February, 2021, and the time is 9:30 A. M. to 4:00 P. M. The venue is Swami Vivekananda Block, Justice Hegde Seminar Hall. The website www.reva.edu.in is provided. The poster also features logos for REVA University, ARIIA, and various accreditation bodies like UGC, NIRF, and ESUR.

**REVA UNIVERSITY**  
Bengaluru, India  
Established as per the section 2(11) of the UGC Act, 1956  
Approved by AICTE, COA and BCI, New Delhi

UGC NIRF ESUR  
ARIIA  
ASAT KANAKA UPADHYAY  
FOR INNOVATION, ACHIEVEMENTS

School of Computing and Information Technology  
School of Computer Science and Engineering  
in association with RPA Club and UiPath

Organises

**One Day Hands-on Workshop on  
Robotic Process Automation using UiPath Studio**

Date : 13<sup>th</sup> February, 2021  
Time : 9:30 A. M. to 4:00 P. M.

Venue: Swami Vivekananda Block  
Justice Hegde Seminar Hall

[www.reva.edu.in](http://www.reva.edu.in)

**DIRECTOR**

School of Computing and Information Technology  
REVA University, Rukmini Knowledge Park,  
Kattigenahalli, Yelahanka, Bengaluru - 560064

**REPORT ON COMPETITION ATTENDED FROM VISUAL ART CLUB  
SCHOOL OF ARCHITECTURE**

Date: 04/05/2021

Faculty coordinator: Asst .Prof Dr.Anupama RM

Event: Comic Strip Challenge

Venue: Online

No of students participated = 7

School of Architecture, REVA University, Visual Art Club had organized a Comic Strip Challenge Competition for all the Architecture Students and Faculties. The theme for the competitions: "Life in Pandemic"

Chaotic life of people in this pandemic has changed the life style critically, if not forever. This situational changes has been used creatively by our students to project their ideas vividly.

In this event 5 of 1st semester, 1 of 4<sup>th</sup> semester, 1 of 9<sup>th</sup> semester students participated and WON 1<sup>st</sup>, 2<sup>nd</sup> & 3<sup>rd</sup> prize.

1st prize winner: Ashwin Kumar

2nd price winner: Bharath Kumar

3rd price winner: Neha C K

**LIST OF STUDENT'S PARTICIPATED**

Neha

Bharath Kumar

Ashwin Kumar

Rashmitha R

Yash Bharath Patil

Panchami Chengappa



Anusha Kanchapler

I would like to thank our Director in charge Prof. Vidya Srikanth for her immense support.

1st PRICE WINNER

2<sup>nd</sup> PRICE WINNER

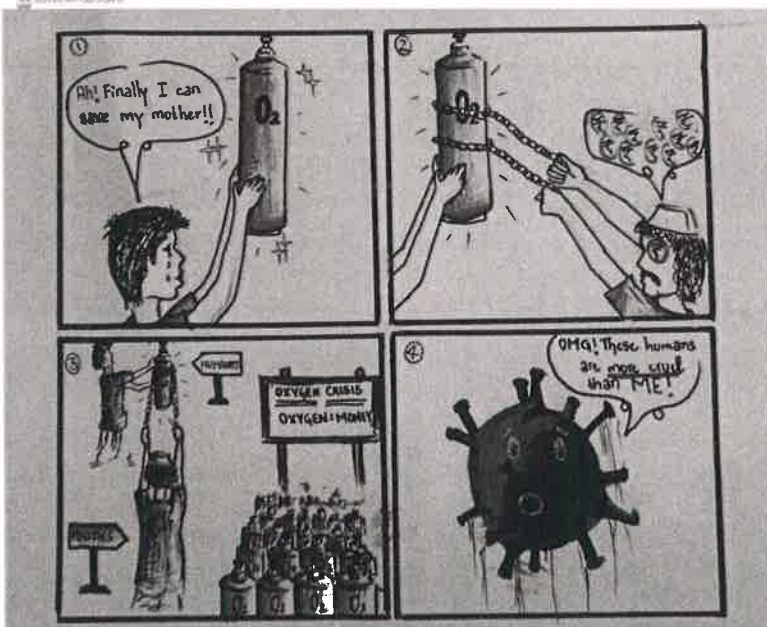
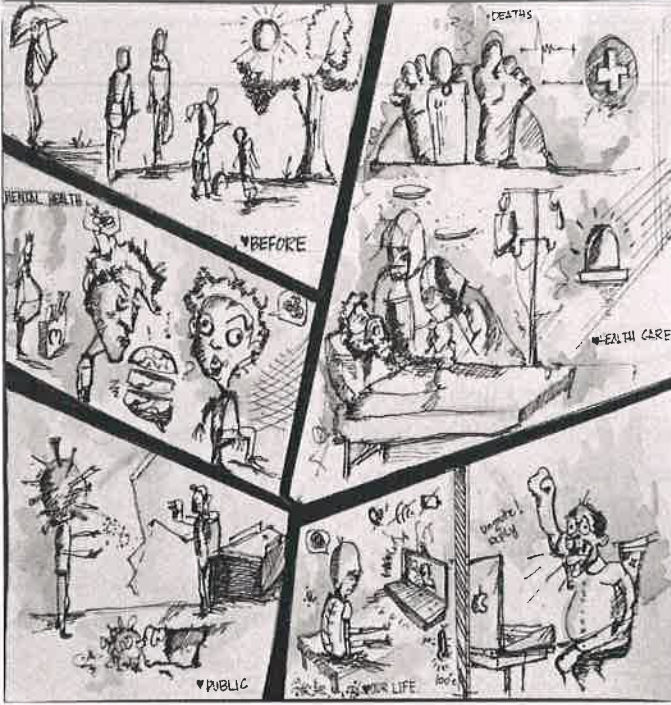

3rd PRICE WINNER

*Vidya Srikanth*  
 02/05/21

REPORT ON KIRIYA SAMPADAKA CULTURAL CLUB

SCHOOL OF ARCHITECTURE

Date: 15/3/2021

Time: 10.00am onwards

Faculty coordinator: Asst .Prof Dr.Anupama RM

Cultural Club Coordinator: Asst .Prof Dr.Anupama RM, Asst .Prof Shwetha B

Event: **Kiriya Sampadaka - 3 award function at REVA University.**

Venue: Kuvempu Auditorium

Students: 6<sup>th</sup> Semester and 4<sup>th</sup> semester

No of students in the dance: 16

6<sup>th</sup> SEM students=1

4<sup>th</sup> SEM students=1

**Asianet Suvarna News Kannada had organized the Grand Finale of Kiriya Sampadaka - 3 award function Program at REVA University, on 15/3/2021 Monday in Kuvempu Auditorium.**

The event followed by Lamp lighting , prize distribution for the winners of Kiriya Sampadaka , Semi classical dance from School of Performing arts and Western dance with skit.

Our Students Prajvala GR from 4<sup>th</sup> semester and Amrutha from 6<sup>th</sup> semester participated in Western Dance in this prestigious show, and which was also telecasted in Asianet Suvarana News kannada channel on 28/03/2021.

I would like to thank our Director in charge Prof. Vidya Srikanth for her immense support.

I would like to extend our thanks to all Professors, Associate professors, and Assistant professors



*Vidya Srikanth*  
 18/3/21



REPORT ON CULTURAL CLUB SAMARTHANA-1.0.2021

SCHOOL OF ARCHITECTURE

Alumni interaction session with the new batch: An end is just another Beginning

Date: 9/1/2021

Time: 2.00PM – 4.30PM

Faculty coordinator: Asst .Prof Dr.Anupama RM ,Asst .Prof Shwetha.B

Event: “Samarthana 1.0: An End is another new beginning”

Venue: Kalpana Chawla Hall

Students: Alumni Batch-2015 and 1st semester students 2020-21

No of students: Alumni students =25

1st SEM students=60

We the School of Architecture, as part of Alumni Student Mentorship Programme have conducted an event “Samarthana 1.0: An End is another new beginning” and interactive session between our first Alumni batch of 2020 and the new batch of 2020-2025, on 9th January 2021.

This session was conducted to motivate the new students by sharing the lessons of inspiring Architectural journey by the Alumni batch at the School of Architecture REVA University. Students have shared their perspective on the importance of always being in the learning mode. This platform has given foster meaningful mentoring relationships between Alumni and current students, like a buddy system wherein the super senior batch take on role of guide and mentor to one or more first semester students.

This event consist of Singing by 1<sup>st</sup> semester Shwetha , Dance performance by 1<sup>st</sup> semester Omkar, Garnisha, Satya, Neelisha, Vilson, Saketh, Beat boxing &

Instrumental entertainment by 5<sup>th</sup> semester Samual. Audience enjoyed the event & made the event successful.

I would like to thank our Director in charge Prof. Vidya Srikanth for her immense support.

I would like to extend our thanks to all Professors, Associate professors, and Assistant professors



*Vidya Srikanth*  
12/01/21

## REPORT ON CULTURAL CLUB FRESHER'S WEEK

### SCHOOL OF ARCHITECTURE

**To carry out a fun and creativity inspiring week of interactions between Fresher's and seniors this event was organized**

Dates: 15th – 18th March, 2021

Faculty coordinator: Asst .Prof Dr.Anupama RM , Asst .Prof Shwetha.B

Student Coordinators: Student Council (2021 batch)

Event: Fresher's Week

Venue: Art Room

No of student: 40

The Student Council of REVA University School of Architecture had organized a week-long event for the new first years of the department to engage in interactive activities with one another and their seniors.

#### **Key events:**

- Retro day
- Pop Culture day
- Mismatched day
- Halloween 2.0

#### **Retro Day**

Retro day was the first of the week's events, held on 15/03/21, with the primary idea of students being dressed in retro clothes, from any era ranging from the 50's to the 90's.

Students were enthusiastic about this and took part whole heartedly. Aside from this, they were made to fill out a questionnaire to tell the seniors a little bit more about themselves and had a runway walk in the last hour of classes.

### **Pop Culture Day**

Pop Culture day followed retro day, on 16/03/21, where students were challenged to channel pop culture icons or references from the last decade in their clothing for the day.

The 1<sup>st</sup> years were given a bingo card each, with certain characteristics mentioned on each square, to be signed by a senior who fit in those character traits. They were eager to do it and took part with great gumption.

### **Mismatched Day**

The third day was 'Mismatched day' and the students donned typically not seen together combinations and strutted their stuff on another runway walk. The task of the day was to recreate a popular internet meme and they did so, ensuing in complete hilarity and joy.

### **Halloween 2.0**

The fourth and final day was Halloween themed, where all the students of the new batch dressed in spooky costumes, ranging from ghosts to zombies and had a final interactive session where they got to know their seniors of the graduating batch of 5<sup>th</sup> years.

The event was an overall success and had active participation from the 1<sup>st</sup> years, who did not miss a beat and delivered every single day, as well as the seniors who enjoyed getting to know their juniors as much as they could.

I would like to thank our Director in charge Prof. Vidya Srikanth for her immense support.

I would like to extend our thanks to all Professors, Associate professors, and Assistant professors of REVA University School of Architecture for their continuous support and guidance.







REVA  
UNIVERSITY

Bengaluru, India



Vidya Srikant  
20/03/21

**Pictures of the Event:**



**Date: 23.06.2021**

**Traditional Folk Art Heritage - An Insight into Gond Art**

**4 Days Workshop as Skill Development Program**

SDC Workshop: Traditional Folk Art Heritage - An Insight into Gond Art

Date: 16<sup>th</sup> to 19<sup>th</sup> June 2021 (4 days)

Time: 9am – 6pm

Resource person for the Workshop: **Asst.Prof Dr. Anupama R M,**

Venue: Online

Semester: II Semester

No. of students: 28 students

As a part of B.Arch. curriculum the students of 2nd semester from REVA University, School of Architecture has organized a 4 days Skill development program on Traditional folk art heritage- an insight into Gond Art.

Folk art covers all forms of visual art made in the context of culture. The objective of this workshop is to introduce the students about the Folk Art of various community. And it reflects the cultural life of a community.

Resource person- Dr. Anupama R M has formulated a 4 days' workshop for the architecture students to get inspiration on various materials and do a product design keeping the idea of Painting Gond Art.

1st Day students were given an introduction and lecture on Folk Art and different types of Folk Art and Gond Painting with examples. Students were instructed to collect some 10 Gond Artists Names and paintings.

Selecting the painting and sketching on the paper.

2nd Day Resource person gave a demonstration on how to paint the detailing of Gond Art and students started painting by the guidance of the resource person and submitted the work.



3rd Day Students were given a new challenge that to create a painting on contemporary life keeping the Gond style. Students sketched by getting guidance by resource person and painted them.

4th Day Students were instructed to play on different mediums to make a design like wood, hand kerchief, water bottle, fabric etc. and painted them.

The outcomes of this 4 day workshop benefited the students to produce 3 to 4 beautiful art works on different mediums and they have participated with lot of enthusiasm and fun. The brainstorming and exercise will develop their intellectual skills.

I would like to thank our Director in charge Prof. Vidya Srikanth for her immense support.

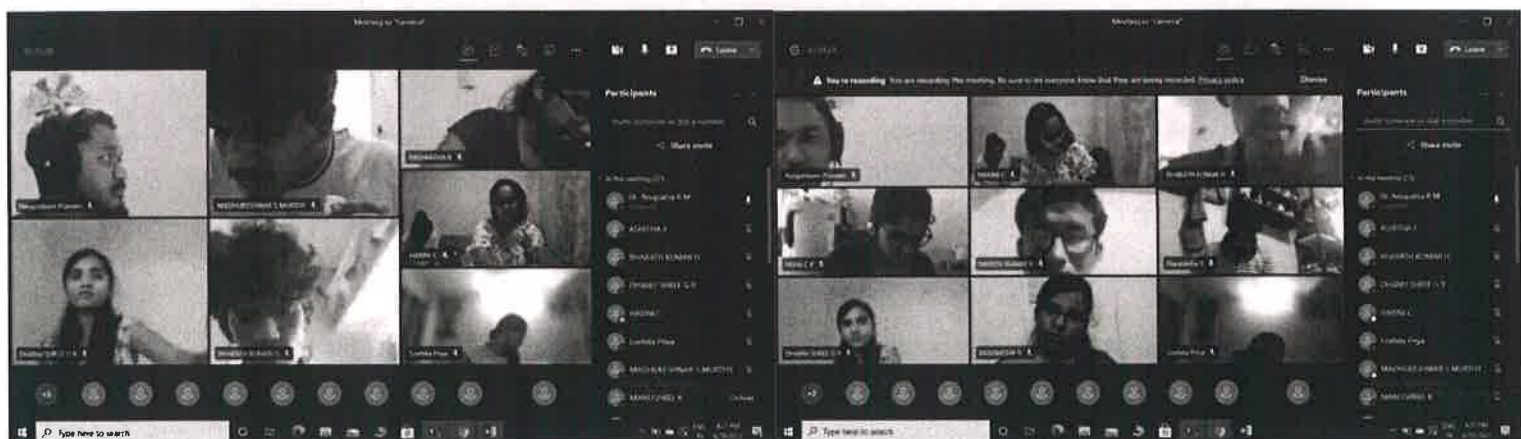
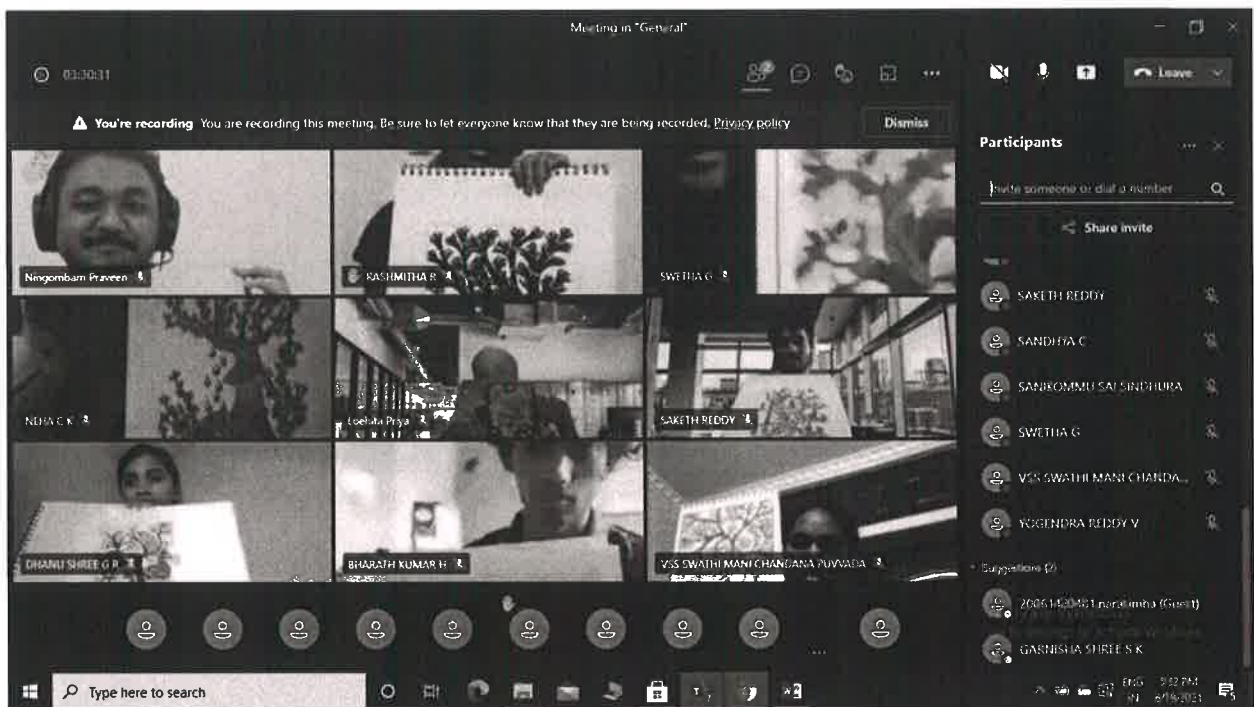





REVA  
UNIVERSITY

Bengaluru, India

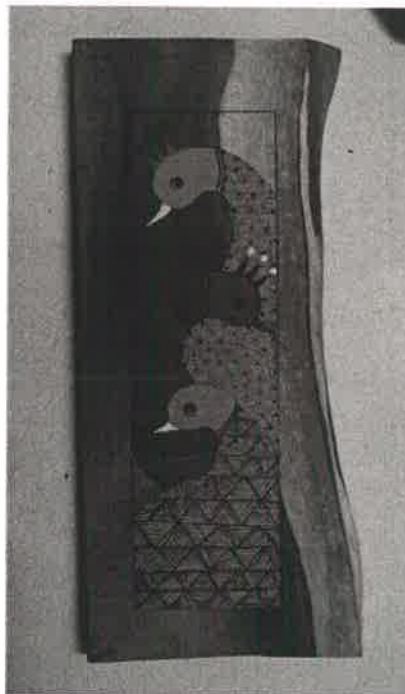
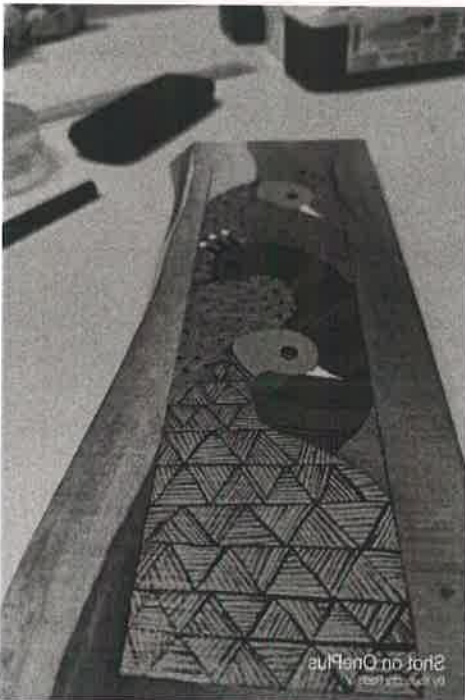

Medium : Water Bottle, Wood, Paper & Hand kerchief





REVA  
UNIVERSITY

Bengaluru, India





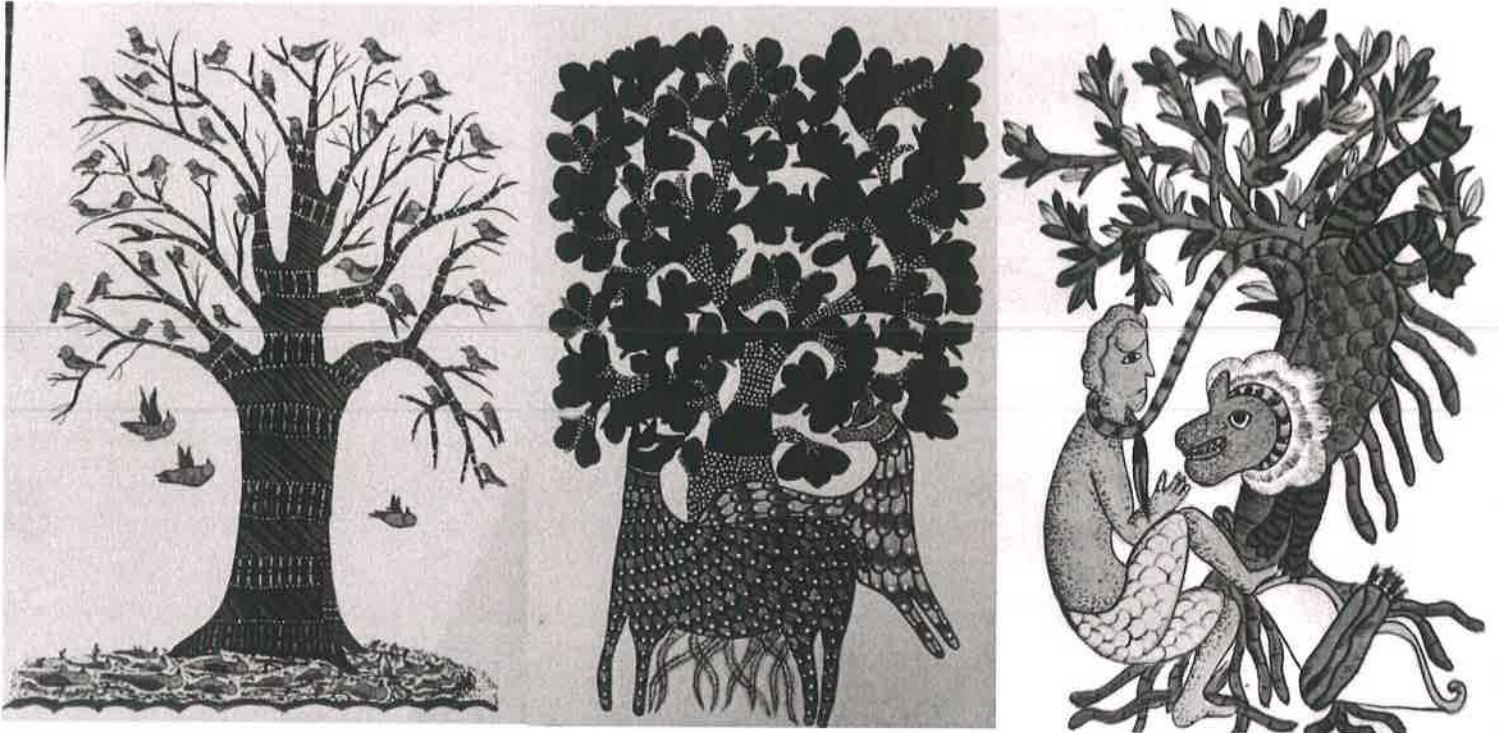

GOND ART

*Vedya Sankar*  
24/06/21



REPORT ON COMPETITION ATTENDED FROM VISUAL ART CLUB  
SCHOOL OF ARCHITECTURE

Date: 19/03/2021

Time: 1.00pm to 3.30pm

Faculty coordinator: Asst .Prof Dr.Anupama RM

Event: World Water Day

Venue: Civil Department

No of 1st SEM students participated = 4

School of Civil Engineering, REVA University, Bengaluru in association with Smt.Rukmini Shyama Raju Club and Prathibha Anveshna Club organized Poster Making and Rangoli Competition on the occasion of WORLD WATER DAY on 19th March, 2021.

The theme for both the competitions: “Water –The Elixir of Life”

In this event from the visual art club 4 of 1st semester students participated in Poster making competition and WON 1st & 2nd prize.

1st prize winner: Neha C K

2nd price winner: Ann C Anil

LIST OF STUDENT’S PARTICIPATED

Neha



Ann C Anil

Bharath

Rashmitha

I would like to thank our Director in charge Prof. Vidya Srikanth for her immense support.

I would like to thank our Civil Dept. for giving us this opportunity.

1st PRICE WINNER

2nd PRICE WINNER

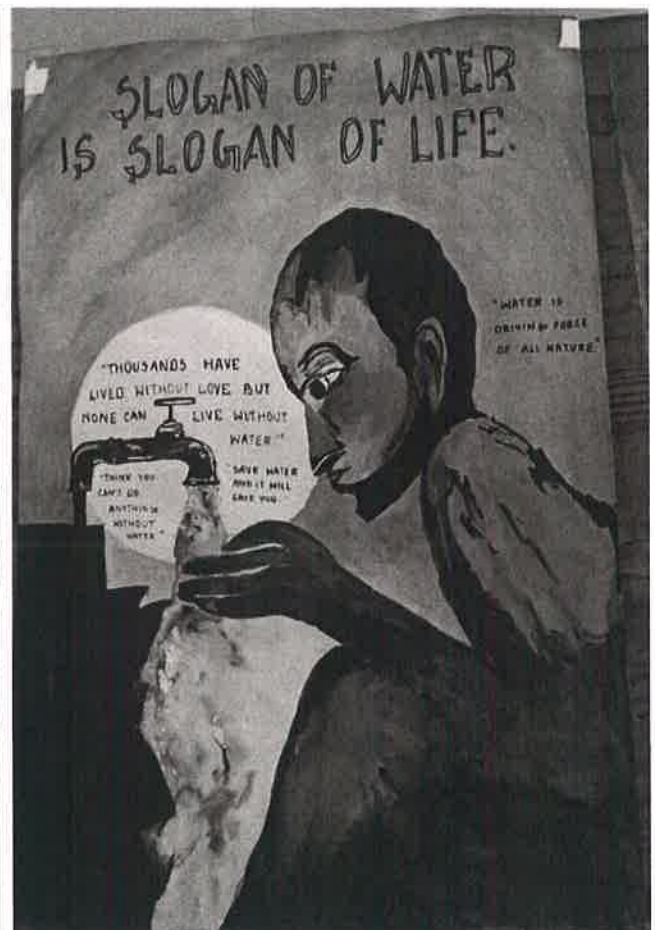



# REVA UNIVERSITY

Bengaluru, India



*Vedant Srikant*  
24/03/21



REPORT ON COMPETATION ATTENDED FROM VISUAL ART CLUB  
SCHOOL OF ARCHITECTURE

Date: 4/2/2021

Time: 11.00am to 12.30pm

Faculty coordinator: Asst .Prof Dr.Anupama RM

Event: **National Energy Conservation Week** Rangoli competition.

Venue: Saugandhika

No of 1st SEM students participated =20

**School of Mechanical Engineering**, REVA University, Bengaluru in association with Karnataka Renewable Energy Development Ltd (KREDL) organized **National Energy Conservation Week** from 29.01.2021 to 05.02.2021.

**National Energy Conservation Week** was celebrated with following activities:

1) Quiz competition related to Energy Conservation 2) Debate 3) Collage Making competition 4) Ideathon 5) Lecture on Energy Conservation 6) Rangoli Competition for staff and students 7) Rally to create the awareness about Energy Conservation.

**Importance of Energy Conservation Week:**

This program focuses on making people to aware about global warming, climate change and promotes efforts towards saving energy resources.

In this event from the visual art club 20 of 1<sup>st</sup> semester students participated in **RANGOLI competition** and **WON 1<sup>st</sup> & 3<sup>rd</sup> prize.**

**1<sup>st</sup> prize winners: Bharath & Rashmitha**

**3<sup>rd</sup> price winners: Garnisha & Arnala**

## LIST OF STUDENT'S PARTICIPATED

Neha

Vaishnavi

Ann

Sandhya

Bharath

Rashmitha

Sindoora

Narasimha

Saketh Reddy

Shwetha

Vanush

Neelisha

Arnala

Garnisha

Vaishnavi Borale

Vishaka

Kaveri Gowda

Namratha

Omkar

Chandana



I would like to thank our Director in charge Prof. Vidya Srikanth for her immense support.

I would like to thank our Mechanical Dept. for giving us this opportunity.

1st PRICE WINNER RANGOLI

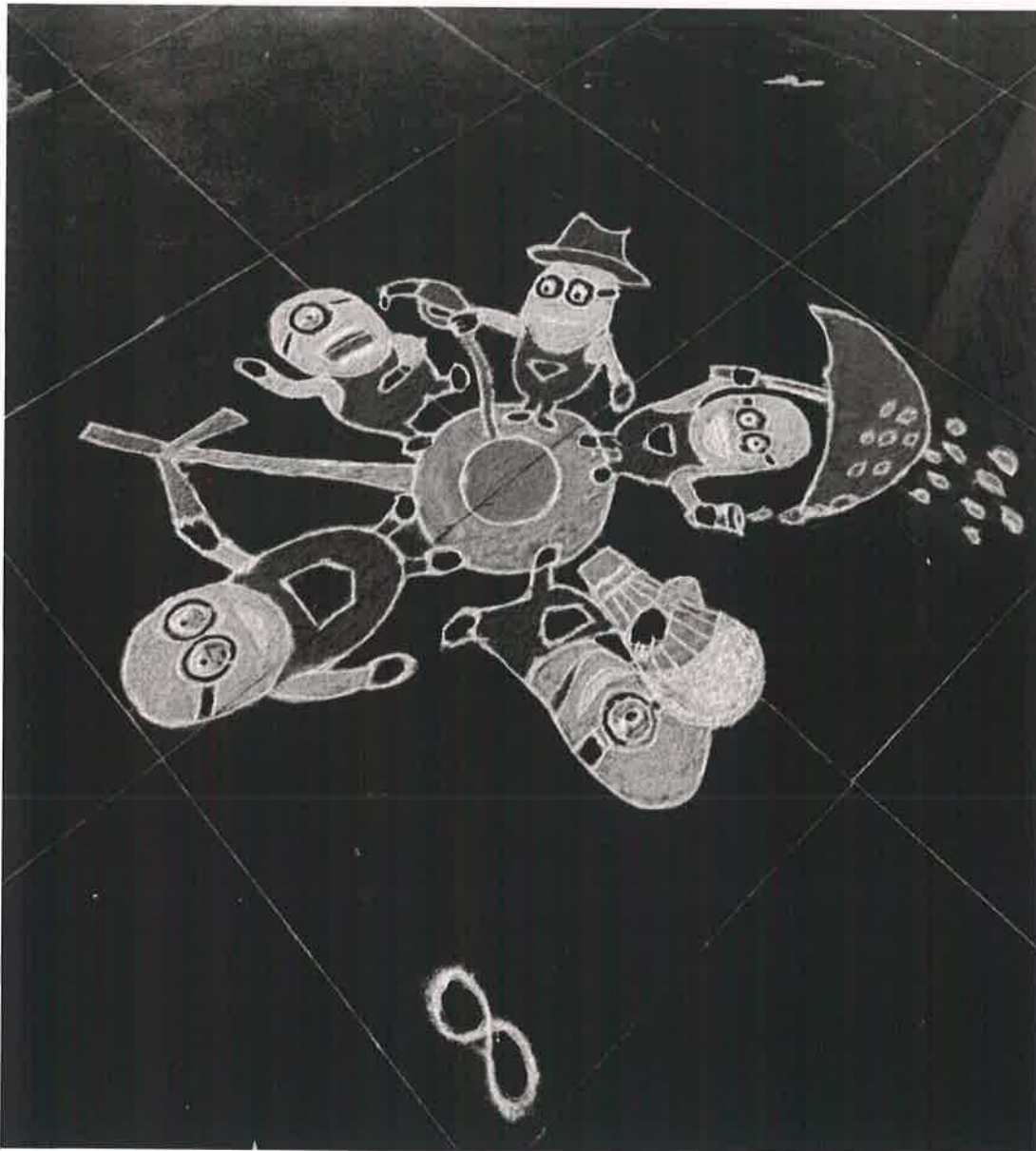

3<sup>rd</sup> PRICE WINNER RANGOLI

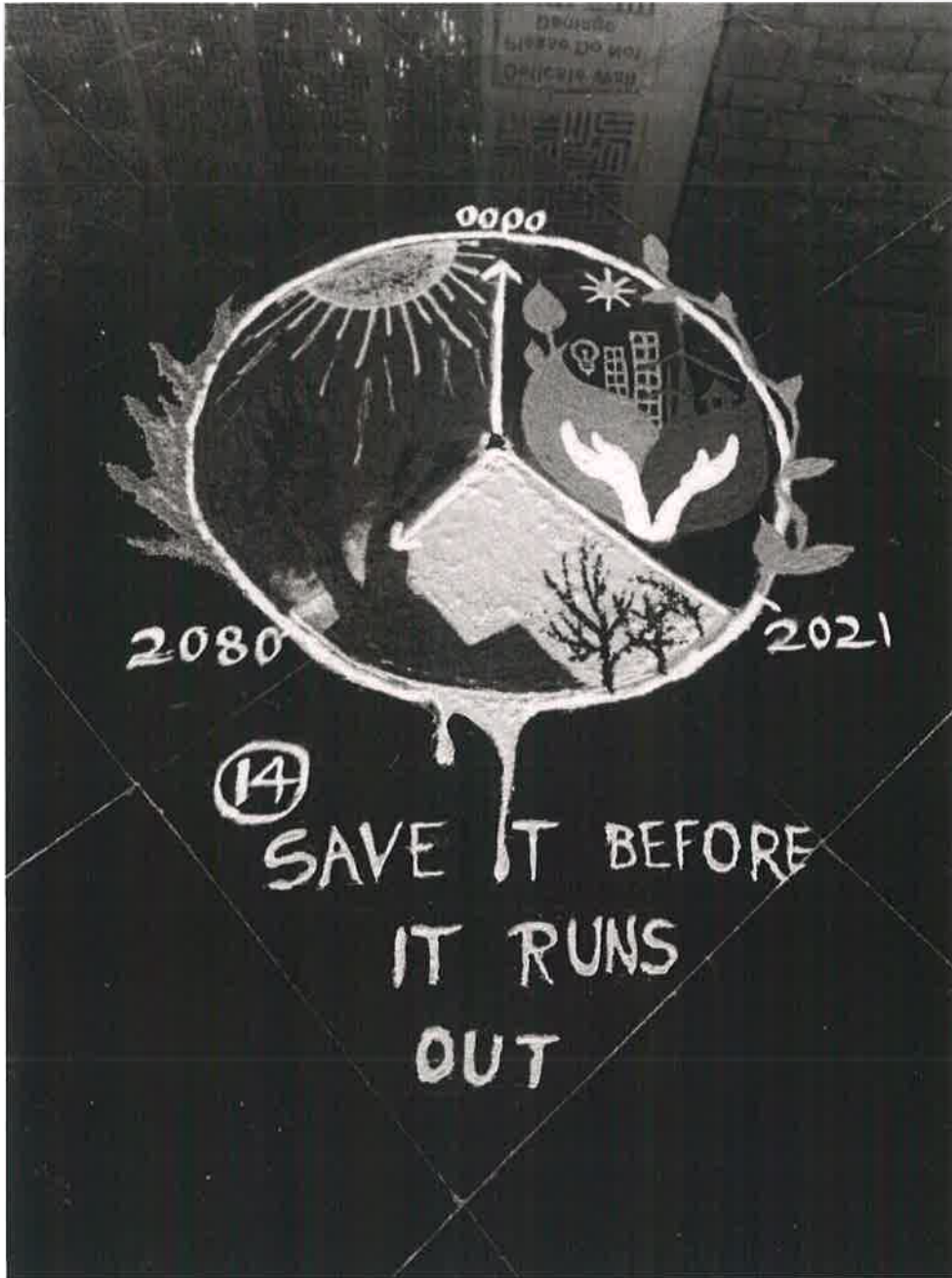

*Vidya Srikant*  
7/2/21



## REPORT ON VISUAL ART CLUB SAMARTHANA-1.0. 2021

### SCHOOL OF ARCHITECTURE

Alumni interaction session with the new batch: An end is just another Beginning

Date: 9/1/2021

Time: 2.00PM – 4.30PM

Faculty coordinator: Asst .Prof Dr.Anupama RM

Event: “Samarthana 1.0: An End is another new beginning”

Venue: Kalpana Chawla Hall

Students: Alumni Batch-2015 and 1st semester students 2020-21

No of students: Alumni students =25

1st SEM students=60

We the School of Architecture, as part of Alumni Student Mentorship Programme have conducted an event “Samarthana 1.0: An End is another new beginning” and interactive session between our first Alumni batch of 2020 and the new batch of 2020-2025, on 9th January 2021.

This session was conducted to motivate the new students by sharing the lessons of inspiring Architectural journey by the Alumni batch at the School of Architecture REVA University. Students have shared their perspective on the importance of always being in the learning mode. This platform has given foster meaningful mentoring relationships between Alumni and current students, like a buddy system wherein the super senior batch take on role of guide and mentor to one or more first semester students.

In this event from the visual art club students painted a CARICATURE of all the Alumni students for the event and presented them.

The CARICATURE team.

Guru Kiran

Aimen

Alen Joseph

Omkar

Nikath Fathima

Rakshitha

I would like to thank our Director in charge Prof. Vidya Srikanth for her immense support.

I would like to extend our thanks to all Professors, Associate professors, and Assistant professors







REVA  
UNIVERSITY  
Bengaluru, India

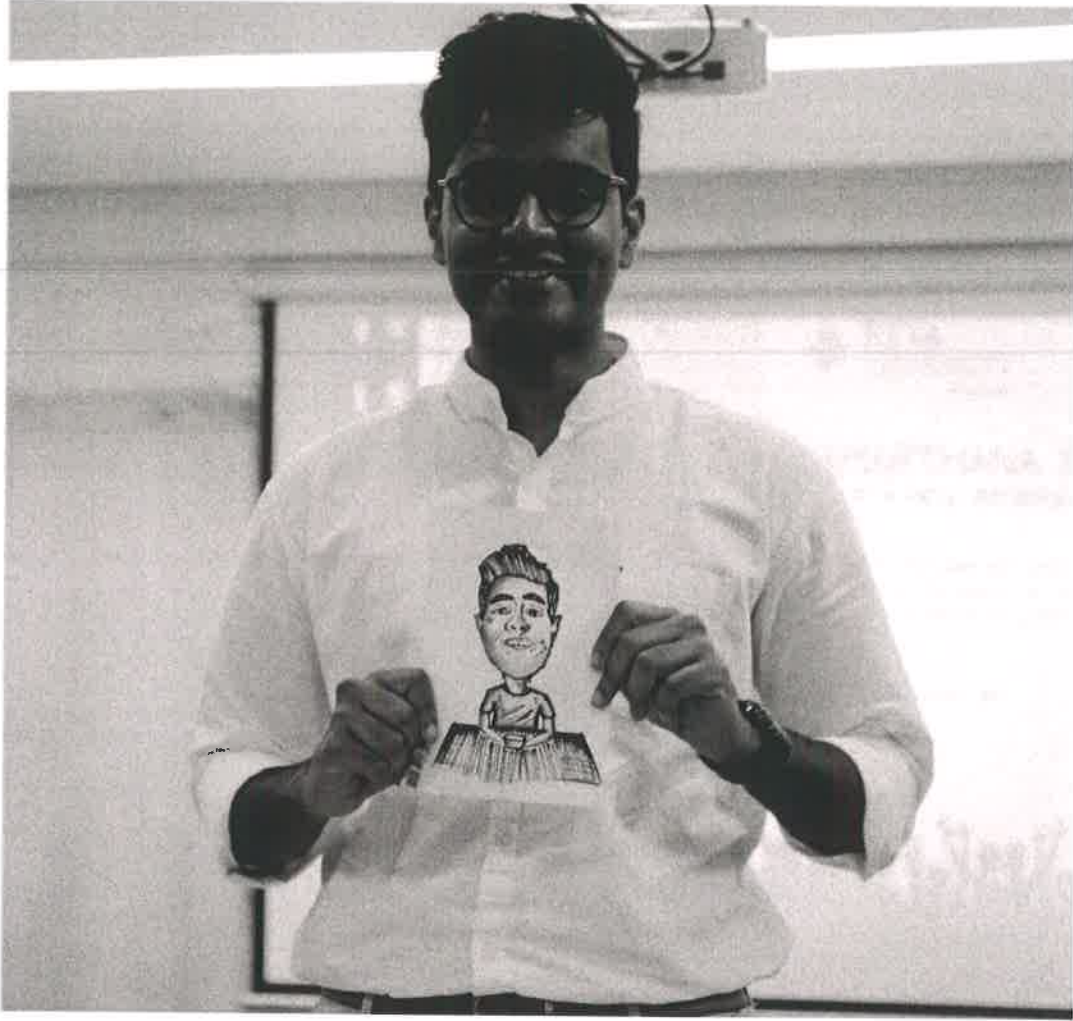

Vidya Srikant  
12/01/21



## REPORT ON VISUAL ART CLUB REVA RACHANA. 2021

### SCHOOL OF ARCHITECTURE

Date: 24/03/2021

Time: 2.00PM – 4.30PM

Faculty coordinator: Asst .Prof Dr.Anupama RM, Asst .Prof Divya Hemanth Raju,  
Asst .Prof Prerana Hazarika,

Course teachers: Asst .Prof Mahima Jagadesh Asst .Prof Sriviji Nachimuttu

Visual Art club coordinator: Asst .Prof Dr.Anupama RM

Resource person for the Workshop: Inhouse faculty, Asst .Prof Dr.Anupama RM

Event: REVA RACHANA 2021 pre event WORKSHOP series 01

Venue: Room no 125 Architecture Block

No of students: 60 1st SEM students

School of Architecture, REVA University takes pride in constantly inculcating creativity in the minds of our students. Our annual flagship event REVA Rachana is an effort towards the same where students get to exhibit their varied talents in the realm of creativity as well as entrepreneurship. This year REVA RACHANA 2021 will be conducted outside the campus for the 1<sup>st</sup> time in RANGOLI metro Art Gallery MG road for more exposure to the students.

As a preparation for REVA RACHANA School of Architecture conducted a pre event WORKSHOP

Series 01- BOOK MARK WORKSHOP

Resource person gave a lecture and a demonstration on how to do the book marks.

1<sup>st</sup> semester 60 students were involved in making paper book marks. Handmade sheets, paints, textured sheets were used for the making.

Students were very excited and benefited by all the workshop conducted.

I would like to thank our Director in charge Prof. Vidya Srikanth for her immense support.

I would like to extend our thanks to all Professors, Associate professors, and Assistant professors

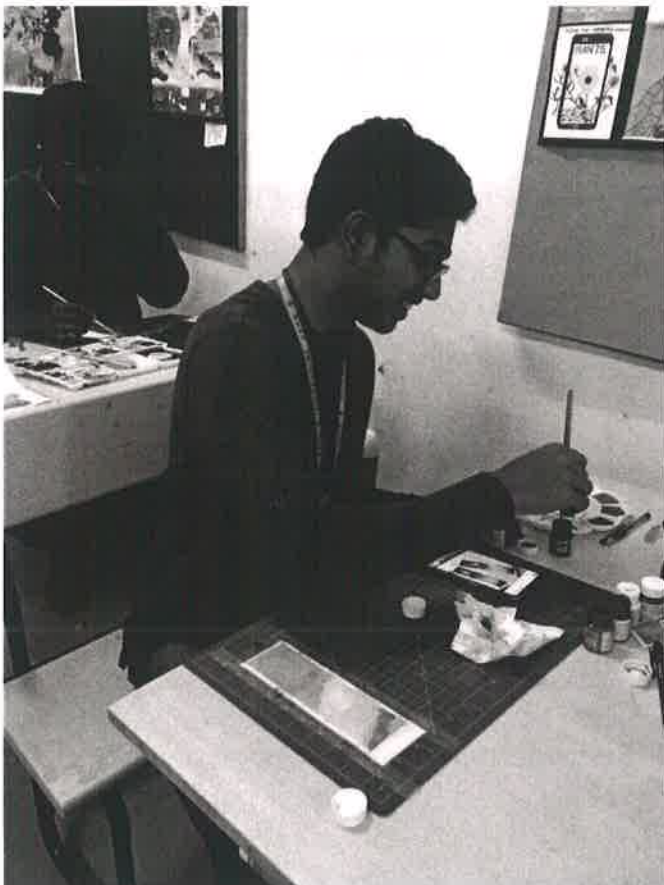





Vidya Sankar  
26/03/21



## REPORT ON VISUAL ART CLUB REVA RACHANA. 2021

### SCHOOL OF ARCHITECTURE

Date: 9/04/2021

Time: 12.00PM – 4.30PM

Visual Art club coordinator: Asst .Prof Dr.Anupama RM

Faculty coordinator: Asst .Prof Dr.Anupama RM, Asst .Prof Mahima Jagadesh,  
Asst .Prof Shreya Mishra,

Resource person for the Workshop: In-house faculty, Asst .Prof Dr.Anupama RM

Event: REVA RACHANA- 2021 pre event WORKSHOP series 02

Venue: Room no 125 Architecture Block

No of students: 10 1st SEM students

School of Architecture, REVA University takes pride in constantly inculcating creativity in the minds of our students. Our annual flagship event REVA Rachana is an effort towards the same where students get to exhibit their varied talents in the realm of creativity as well as entrepreneurship. This year REVA RACHANA 2021 will be conducted outside the campus for the 1<sup>st</sup> time in RANGOLI metro Art Gallery MG road for more exposure to the students.

As a preparation for REVA RACHANA School of Architecture conducted a pre event WORKSHOP

Series 02- Terracotta Jewelry making

Resource person Asst .Prof Dr. Anupama RM, in-house faculty gave a lecture on the importance of natural clay and its nature and a demonstration on how to use the natural clay to make trendy jewelry.

1<sup>st</sup> semester 10 students were involved in this terracotta jewelry making workshop. Natural terracotta clay, tools for jewelry making and fabric paints were used. Students were benefited by the learning of the jewelry making and different techniques, methods. Students were able to make a beautiful trendy pendants, earring and neck ware in the workshop.

Students were very excited and benefited by the workshop conducted.

I would like to thank our Director in charge Prof. Vidya Srikanth for her immense support.

I would like to extend our thanks to all Professors, Associate professors, and Assistant professors







*Vidya Srinivas*  
12/04/21



**REVA**  
**UNIVERSITY**

Bengaluru, India

**SCHOOL OF COMPUTING AND INFORMATION TECHNOLOGY  
IN ASSOCIATION WITH INTERNAL QUALITY ASSURANCE CELL(IQAC)  
PRESENTS A WEBINAR**

**on**

**"Machine Learning, Artificial Intelligence and Beyond "**

**DATE: 02-01-2021**

<b>About the Webinar</b>	<p>The new School of Computing and Information Technology organized webinar on <b>Machine Learning, Artificial Intelligence and Beyond</b> In Association with IQAC REVA University, on 2nd Jan 2021 for our faculty members and students to gain the cutting edge knowledge on artificial intelligence and machine learning. Artificial Intelligence (AI) and Machine Learning (ML) are perfect examples of disruptive innovation. Innovation is an important driver for a successful enterprise. AI and ML can be applied in almost any organization. Large investments are no longer necessary to start an AI / ML project. However, the idea that AI and ML is the sole domain of experts from Harvard is hard to overcome, as well as the idea that starting an AI and ML project requires a considerable investment: in knowledge, hardware and software. With the rise of AI first companies (Google, AWS, Azure) offering ready to use ML models and tools for different problems, and the increase of smart, AI enabled edge devices, the demand for AI and ML education will grow evenly.</p>
<b>Organized By</b>	School of Computing & Information Technology in Association with Internal Quality Assurance Cell (IQAC), REVA University.
<b>Date</b>	02-01-2021 10:30am – 12:00 pm
<b>Convener</b>	Dr. Sunil Kumar S. Manvi, Dean, Faculty of Engineering & Technology, Director, School of CIT and CSE, REVA University.  Dr. Mallikarjun M Kodabagi, Professor and Assistant Director, School of Computing and Information Technology, REVA University.
<b>Organizing Chair</b>	Dr. Mallikarjun M Kodabagi, Professor and Assistant Director, School of Computing and Information Technology, REVA University.
<b>CO-ORDINATORS</b>	Prof. Pavithra, Prof. Sarvamangala, Prof. Surendra Babu K N, Prof. Rashmi C, Prof. Lalitha, , Prof. Aruna Kumara B.
<b>Targeted Audience</b>	Faculties and Students
<b>Resource Persons</b>	<b>Dr. Ramabrahmam</b> Senior Data Scientist Tata Consultancy Services Limited

  
**DIRECTOR**  
School of Computing and Information Technology  
REVA University, Rukmini Knowledge Park,  
Kattigenahalli, Yelahanka, Bengaluru - 560064

<b>No. of Participants</b>	<b>96</b>
<b>Link</b>	<a href="https://web.microsoftstream.com/video/0abcc9fb-54a0-4679-b318-9dd9e8ff584e">https://web.microsoftstream.com/video/0abcc9fb-54a0-4679-b318-9dd9e8ff584e</a>

### Photographs during the Webinar

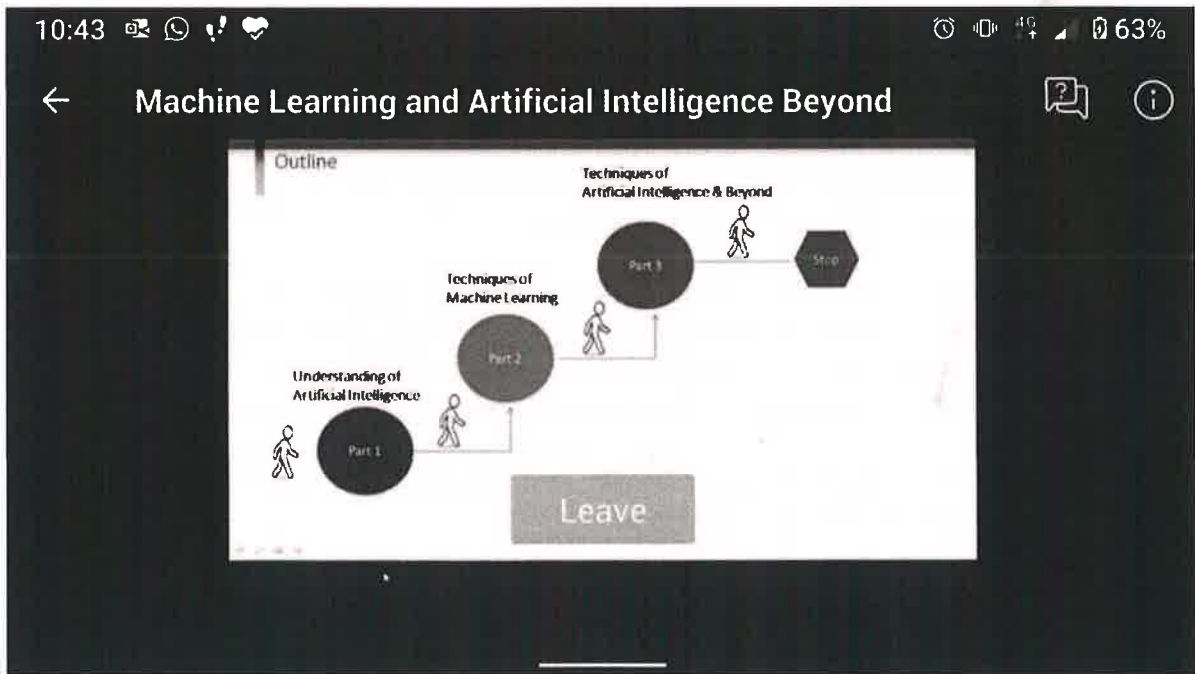
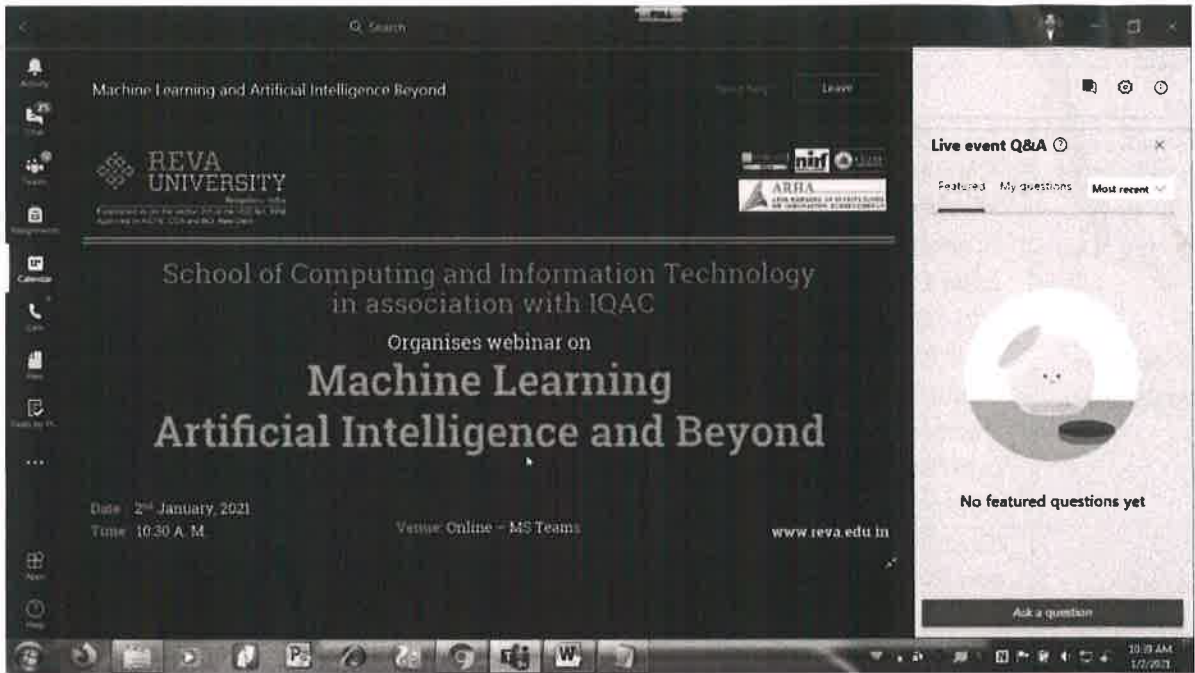

  
**DIRECTOR**  
 School of Computing and Information Technology  
 REVA University, Rukmini Knowledge Park  
 Kattigenahalli, Yelahanka, Bengaluru - 560066

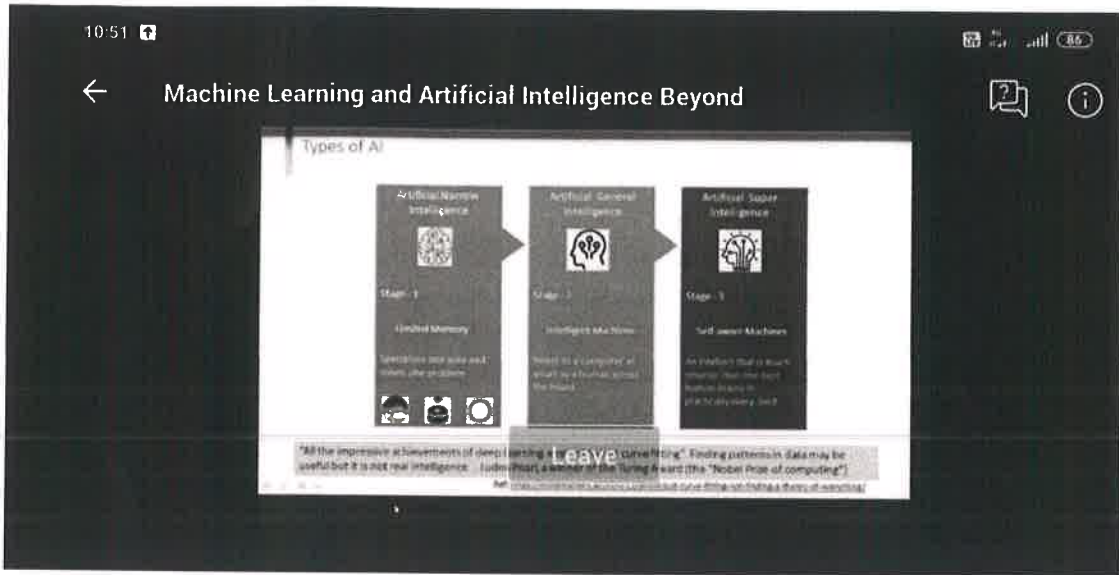

\*\*\*\*\*

**DIRECTOR**  
School of Computing and Information Technology  
REVA University, Rukmini Knowledge Park,  
Kattigenahalli, Yelahanka, Bengaluru - 560064.





**REVA**  
**UNIVERSITY**

Bengaluru, India

**School of Computing and Information Technology  
Organizes**

**“Technical talk on SOCIAL IOT & APPLICATIONS”**

**DATE:05-03-2021**

<b>About the Program</b>	<p>The School of Computing and Information Technology Organized technical talk on <b>“SOCIAL IOT &amp; APPLICATIONS”</b></p> <p>The Program aimed at bringing awareness among students about social Internet of things and applications</p> <p>Dr. Mallikarjun M Kodabagi , spoke about the importance of the Social IOT and application with some real time examples</p>
<b>Organized By</b>	School of Computing and Information Technology
<b>Date</b>	05-03-2021 at 3:00 Pm
<b>Convener</b>	<p>Dr. Sunil Kumar S. Manvi, Dean, Faculty of Engineering &amp; Technology, Director, School of Computing and Information Technology, REVA University.</p> <p>Dr. Mallikarjun M Kodabagi , Professor and Assistant Director, School of Computing and Information Technology, REVA University.</p>
<b>Organizing Chair</b>	Prof.Ravishankar H, Prof. Sowmya Sundari L K, Prof.Anitha K
<b>Targeted Audience</b>	1 <sup>st</sup> sem and 4th sem students of School of CIT
<b>Delegates</b>	1. Dr. Mallikarjun M Kodabagi , Professor and Assistant Director, School of Computing and Information Technology, REVA University.
<b>No. of Participants</b>	53
<b>Topics</b>	<p><b><u>Topics Covered in meet are:</u></b></p> <ul style="list-style-type: none"><li>• Introduction to IOT</li><li>• Real time applications of IOT</li><li>• Social IOT</li></ul>

**Photograph**



**DIRECTOR**

School of Computing and Information Technology  
REVA University, Rukmini Knowledge Park,  
Kattigenahalli, Yelahanka, Bengaluru - 560064

**School Name: CSA**

**Activities Conducted 2020-21**

**Club name: Software Club**

**Date:** 10<sup>th</sup> to 31<sup>st</sup> July 2020

**Number of participants:** Total 63 Students

**Activity Conducted:** Hackathon

Hackathon was scheduled from 10<sup>th</sup> July 2020 to 31<sup>st</sup> July 2020, to replace the Chinese apps by alternative app and solving few problem statements of COVID -19. The participants were students from BCA, BS, and MCA, MS. The registration was free. The first three Best Teams were awarded with cash prizes-1<sup>st</sup> Prize –Rs.7.5k, 2<sup>nd</sup> Prize – Rs.5k, 3<sup>rd</sup> Prize – Rs.2.5K, The outcome of the Hackathon were - Replacement of UC News with R-News & Shareit app with R-ShareiT app by BCA and M.Sc Students.

**Attendance:** Event was online

Sl.no	Guide	Course	SRN	Name	Project Title
1	Vijayalaxmi Chiniwar	MCA	R19CA881	Vaishak Chavan A	System for Tracing contacts and travel history using GPS to track history and present.
2	Bhagya M Patil	MS	R19SCS07	Tushar	To develop an Alarm Bell when social distance not maintained in shops or on movement in roads.
3	Amutha A	MS	R19SCS38	VIJAY RAVIRAJ GUDI	Xender APP
4	Shreetha Bhat	BSc(R)	R17BS032	SABARI VIGNESH	Visualization of COVID-19 Cases In India
5	Sneha N	MS	R19SCS21	Kulsum and Pooja	WeChat and File Sharing
			R19SCS12		
6	Dr.VINAYAKA MURTHY	MS	R19SCS08	COULIBALY ATTEITY KOFFI AJAD GUY HAUSMANN BOBOLIBO	People App



7	Deepa B G	MS	R19SCS43	VIKRAM SINGH BHADHORIA	Predict the cumulative number of confirmed COVID-19 cases in various locations in India as well as fatalities.
8	AryaMol V K	BCA	R18CA170	Roshani. T	System for Tracking health and location of quarantined persons.
9	Abhay Kumar Srivastav	BCA	R18CA056	UJJWAL VATS	I-BROWSER APP FOR ANDROID
10	Abhay Kumar Srivastav	BSc(R)	R17BS028	PRADEEP G	Namma Angadi
11	Vinay	MS	R19SCS28	NOOR SUMAIYA	CLUB FACTORY
12	Lokesh C K	MCA	R18CA614	Mohammed Zeeshan A	Tik Tok – Related
13	G.Sasikala	BSc(R)	R17ca030	P K SAI NIKITHA	Face Mask Detection using Artificial Intelligence
14	Shreetha Bhat	MS	R19SCS29	Pavan kumar P S	FILE SHARING APP
15	Amutha A	BCA	R18CA161-	Mohd Afzal khan	Coronavirus Guide And Tracing (CGAT)
16	K. Vijayalakshmi	MS	R19SCS12	COVID-19 SELF AWARE	COVID-19 Problem Statements
17	M Manjusree	MS	R19SCS01	Arvind	SMART AWARENESS SYSTEM
18	ADITYA.V	BSc(R)	R17BS008-Divyanshu Singh , Vinay R Shankar - R17BS044	Divyanshu	News and Community Forum Android Application
19	A P Bhuvanewari	BSc(R)	R17CA012 - AMULYA R17CA040-SWATHI G	Amulya and Swathi	Alarm bell for Maintaining social distance
20	Krishna murthy		Sourjith and Rachel, Abhjeeth, Nareesh		News
21	Revina	BSc(R)	Anish and Shanshank		Wechat
22	Sneha N	BCA	Jai Surya Varun		UC Browser



**Photographs:**

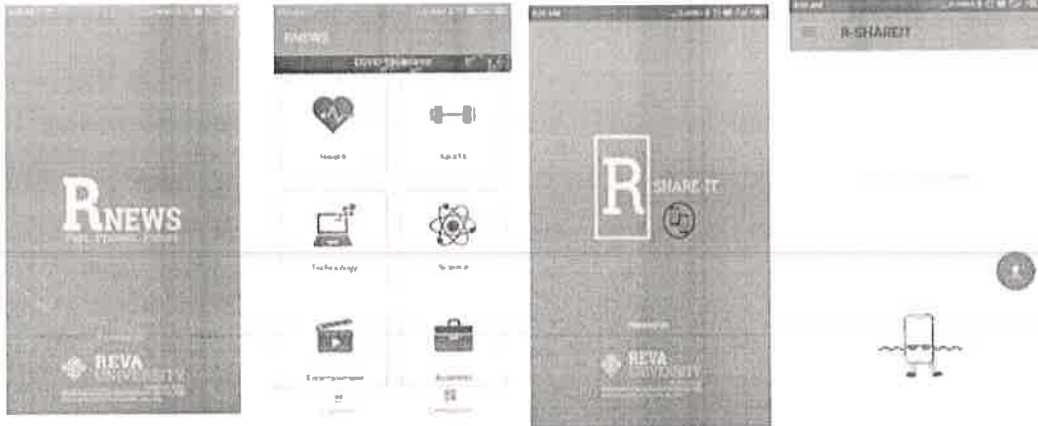

*S. A. R.*

**DIRECTOR**  
School of Computer Science & Applications  
REVA University, Kattigenahalli,  
Bangalore - 560 064.

**Club name: Software and Coding Club**

**Date:** 13<sup>th</sup> and 14<sup>th</sup> July 2020(Online)

**Number of participants:** 100

**Activity Conducted:** Two days of hands on session on Android App Development.

The Session was about providing training for students on android studio and give exposure to develop applications, 100 students participated, session was conducted by Prof.Surekha Mazumdar, Virtual links are shared. The Topics discussed are explanation of the Android Stack, Refreshing the basic programming concepts and Object Oriented Programming, Fundamentals in User Interface Design, Using the UI elements for design, Using logs to track the control, Using Intents to travel from one activity to another activity, Using Intents to send data from one activity to another activity.

**Attendance:** CSA Students

SRN	Name	R17CA052	S P POOJA
R17CA001	AAYUSH VISHWAKARMA	R17CA053	SAHANA D M
R17CA002	ABHISHEK N	R17CA054	SANA BANU R
R17CA003	ADITYA BHARADWAJ J	R17CA055	SANJAY ATHREYAS P
R17CA004	AISHWARYA K V	R17CA056	SHASHANK S V
R17CA005	AKASAM SMRUTHI	R17CA057	SHREYAS V V REDDY
R17CA008	AMRUTHA VARSHINI N	R17CA058	SHUSHMITHA S
R17CA009	ANKITH K R	R17CA059	SNEHA A
R17CA010	ANUSHA A SHETTY	R17CA061	SRIVIDHYA M
R17CA011	BHARGAVI T	R17CA062	SYED LUKMAN HAROON
R17CA012	CHETHAN C	R17CA064	VANITHA R
R17CA013	CHINMAYI V M	R17CA065	VINITH KUMAR V
R17CA014	DEVARAJ MAGRUMKHANE	R17CA066	AASHISH SINGHAL
R17CA015	DHANANJAYA G R	R17CA067	ABHAY INAMDAR
R17CA016	DILIP KUMAR A	R17CA068	ABHISHEK M BADIGAR
R17CA017	G AVINASH	R17CA069	ADITHYA M
R17CA018	G NITHIN RAJAN	R17CA070	ADITHYA R
R17CA019	GAGANA S	R17CA071	ADITYA KUMAR SINGH
R17CA020	GAJULAPALLE SHAMEER	R17CA072	ANJALI RAGHAV
R17CA021	INDRAJEET KUMAR	R17CA073	ANURADHA KUMARI
R17CA022	JAYA KUMAR A	R17CA074	ASHIN K
R17CA023	JOLIAS KERKETTA	R17CA075	BARAT V
R17CA024	JYOTHI LAKSHMI	R17CA076	CHANDRASHEKAR H
R17CA025	KARTHIK KUMAR C	R17CA077	CHITTARI TARUN
R17CA026	KOMALAPATI PAVAN KUMAR	R17CA078	DEEPAK S
R17CA027	LIKHITHA R	R17CA079	DHANUSH V



R17CA028	MANDA YASASWINI	R17CA080	GIRISH S
R17CA029	MANISH KUMAR	R17CA081	GONDALIYA PREKSHA HIMANSHUBHAI
R17CA030	MANOJ R	R17CA082	GOWTHAM G V
R17CA031	MANOJ S	R17CA083	IMRAN AHMED
R17CA032	MEGHANA P	R17CA084	JEEVAN S GOWDA
R17CA034	MOHAMMAD REHAN	R17CA087	K S PANINDRA KUMAR
R17CA035	NAVEEN KUMAR G	R17CA088	KALYAN KUMAR K T
R17CA036	NAYANA G H	R17CA090	KOMALAPATI KRANTHI KUMAR
R17CA037	NILESH KUMAR CHAKRABORTI	R17CA091	KOYEL DAS
R17CA038	NISCHAY REDDY R	R17CA093	M PAVAN KUMAR
R17CA039	NISHAN GAURAV	R17CA096	MUSHFIQUE SHAHOOD
R17CA041	PAVAN D B	R17CA097	MUZAMMIL A
R17CA042	POORNIMA R	R17CA098	N SANTHOSH KUMAR
R17CA043	PRADEEP SSIDDAPPA DODDAMANI	R17CA099	NIKSHITH GOWDA N
R17CA044	PUNITHA E	R17CA100	NISHANT KUMAR
R17CA045	RAJESHWARI A	R17CA101	NITHIN H B
R17CA046	RAKSHITHA J N	R17CA102	ORUGANTI SUSHANTH GOUD
R17CA047	RANIYÓ RAPHEL	R17CA104	PAVAN V R
R17CA048	RANJAN KUMAR GUPTA	R17CA105	PAVITHRA S
R17CA049	REENA B	R17CA106	PRADEEPKUMAR N
R17CA051	ROHITH S	R17CA107	PRAGATHI B R
R17CA111	PUNITH S	R17CA108	PRATHEEK K
R17CA113	RACHIKA TALUKDAR	R17CA109	PRAVEEN K
R17CA114	RAKSHATHA G	R17CA110	PRUTHVI RAJ V
R17CA115	RAKSHITH K SULLAD		

**Photographs / Video:** Links Day 1 and Day 2

[https://teams.microsoft.com/l/meetup-join/19%3ameeting\\_ZDM5MWZhOWQwMC00MTBhLTlIMzktNWl1ZWRhNDhhZGly%40thread.v2/0?context=%7b%22Tid%22%3a%22474565c1-bca4-4295-a2f5-b0c7dbf2591c%22%2c%22Oid%22%3a%22cad0c70-3127-491a-97c9-66d9756d3bd3%22%7d](https://teams.microsoft.com/l/meetup-join/19%3ameeting_ZDM5MWZhOWQwMC00MTBhLTlIMzktNWl1ZWRhNDhhZGly%40thread.v2/0?context=%7b%22Tid%22%3a%22474565c1-bca4-4295-a2f5-b0c7dbf2591c%22%2c%22Oid%22%3a%22cad0c70-3127-491a-97c9-66d9756d3bd3%22%7d)

[https://teams.microsoft.com/l/meetup-join/19%3ameeting\\_ZDM5MWZhOWQwMC00MTBhLTlIMzktNWl1ZWRhNDhhZGly%40thread.v2/0?context=%7b%22Tid%22%3a%22474565c1-bca4-4295-a2f5-b0c7dbf2591c%22%2c%22Oid%22%3a%22cad0c70-3127-491a-97c9-66d9756d3bd3%22%7d](https://teams.microsoft.com/l/meetup-join/19%3ameeting_ZDM5MWZhOWQwMC00MTBhLTlIMzktNWl1ZWRhNDhhZGly%40thread.v2/0?context=%7b%22Tid%22%3a%22474565c1-bca4-4295-a2f5-b0c7dbf2591c%22%2c%22Oid%22%3a%22cad0c70-3127-491a-97c9-66d9756d3bd3%22%7d)

  
**DIRECTOR**  
School of Computer Science & Applications  
REVA University, Kattigenahalli,  
Bangalore - 560 064.



**Web Development Club  
A Brief Report**

About the Club activity	The School of Computing and Information Technology organized Web Development Program for Students.
Organized By	School of Computing and Information Technology
Date	Sep 1st 2020, 2.30 AM to 4.30AM
Organizers	Dr. Mallikarjun Shastry Prof. Sailaja Thota Prof. Anil
Targeted Audience	All students, REVA University
Resource Person(s)	<b>Vishnu Sai – 5B – R18CS081</b> <b>Prof. Sailaja Thota</b>
Student Coordinators	-
Program Conducted	<b>Text translation web applications with mail service</b>
No. of Students Participated	69 students and 4 Faculty
Feedback from Students	Students were happy to learn application oriented concept of text translation using flask framework. Students would like to have more sessions on Saturday and Sunday.
Outcome	Students got an idea about the translation using flask framework which can be used in any other web applications.
Link for the session	<a href="https://web.microsoftstream.com/video/71edf9ba-6395-4e44-9eea-2c014dc0175d">https://web.microsoftstream.com/video/71edf9ba-6395-4e44-9eea-2c014dc0175d</a>
Content	1. Installation steps and environment variable setting in pycharm 2. Installation commands of flask and google translator 3. UI design with html and accessing the same in browser using flask environment 4. Text translation application 5. Mailing service application



<b>CSI Club Activity A Brief Report</b>	
About the activity	The School of Computer Science Engineering organized Webinar on "IoT-Tinkercad Simulator" for Students.
Organized By	The School of Computer Science Engineering
Date	May 29 <sup>th</sup> 2021, 2.00 PM to 3.30PM
Organizers	Dr. Shaik Hussain Anooja Ali
Targeted Audience	All students, School of Computer Science Engineering, REVA University
Resource Persons	Dr. Sathish Kumar Ravichandran Christ University, Bangalore  Prof. Archana Sasi Presidency University, Bangalore
Student Coordinators	-
Program Conducted	IoT- Tinkercad Simulator
No.of Students Participated	160 students
Feedback from Students	Students were happy to know the basics of simulations in IOT, Arduino boards. Most of students are expecting such motivational programs in this pandemic situation.
Outcome	Students got an idea about Simulations in IOT on real time scenarios. Students got to know the Sketch coding, establishing connections with Simulator and the different libraries available in Tinkercad  Students are interested to know the importance of - assignments and projects which will be having more weightage in their curriculum on IOT - Simulation of Arduino projects
Link for the session	<a href="https://bit.ly/34IKF11">https://bit.ly/34IKF11</a>
Content	1. Introduction to IOT, Arduino board 2. Simulation in IOT 3. Installing and Programming with Tinkercad.

**REVA UNIVERSITY**  
Bengaluru, India  
Established as per the section 2F of the UGC Act, 1956  
Approved by AICTE, CGPA and BCI, New Delhi

School of Computer Science and Engineering  
in association with CSI Club Organises a webinar on

# IoT - Tinkercad Simulator



**Prof. Archana Sani**  
Presidency University, Bengaluru



**Dr. Sarthak Kumar Ravichandran**  
Chennai University, Bengaluru

**Organizers :**  
Prof. Anooja Ali  
Dr. Shaik Musarrif S I

**Date :** 29<sup>th</sup> May, 2023  
**Time :** 2:00 P. M to 3:00 P. M

[www.reva.edu.in](http://www.reva.edu.in)      **Registration link:** <https://forms.gle/Jp1VdVmoYwRxhe186>

Snapshot1: Projecting the Banner

Live event      webinar.cit3's desktop is live

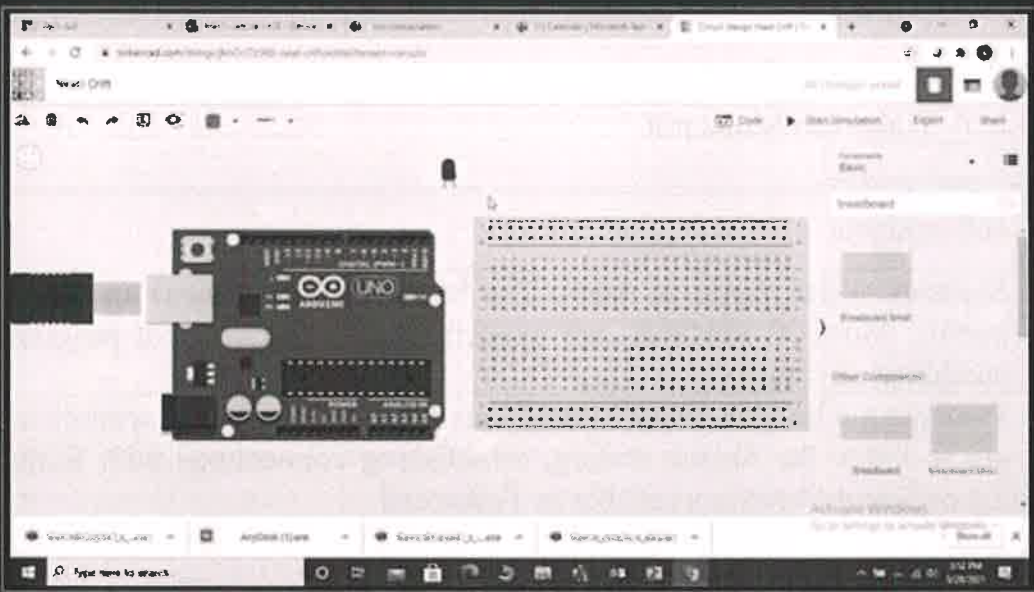

**End**

Snapshot2: Resource person started the talk



Snapshot3: Resource is explaining

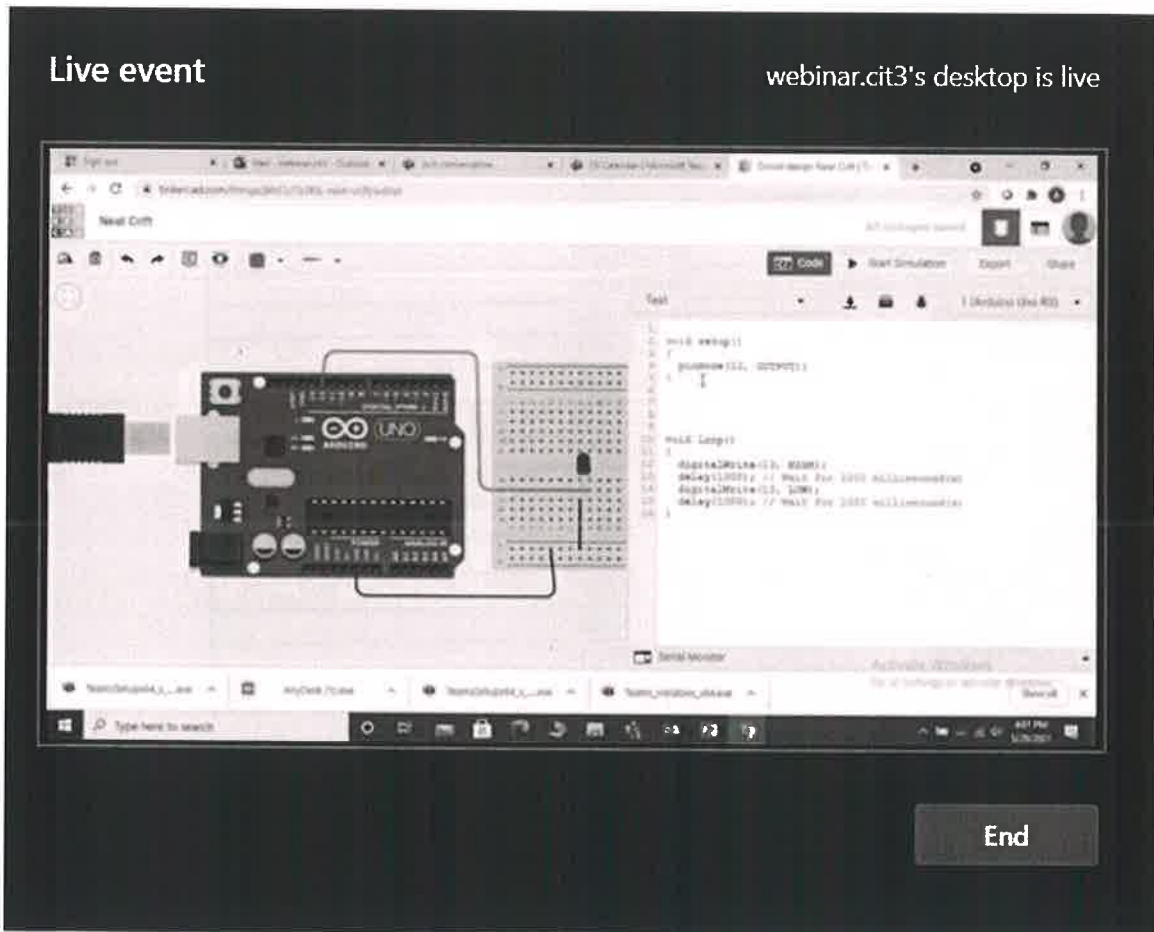



**REVA UNIVERSITY**  
**SCHOOL OF COMPUTER SCIENCE AND ENGINEERING**  
**Webinar on "IoT- Tinkercad Simulator" Attendance list**

Sl. No	Name	SRN
1	Shreeja G L	R18CS406
2	Shrishail Yarandole	R19CS483
3	Goutham Reddy	R18CS174
4	Adithya Jannu	R20CS802
5	Meghanath Shetty	R20CS810
6	Dinesh K	R20CS808
7	Chandan S R	R18CS089
8	Sk md Sahil	R19CS461
9	Shriharinayaka P	R20EM086
10	Rakshitha J Naik	R20EN108
11	Nanditha varshini.E	R20EM061
12	Vinayak k angadi	R20EM097
13	RAJA SAI G	R20EN213
14	Gowri t sridhar	R20EN235
15	Srija H S	R20EN223
16	Mallikarjun v s	R20EN075
17	Ranjan.N	R20EN109
18	Apeksha Bhat	R20EP006
19	U Vachan	R20EP053
20	Aras Amruth.Raj Purushotham	R20EP061
21	Manjunath j s	R20EN076
22	MOHAN BABU T N	R20EN082
23	Rishav	R20ef457
24	Aftab Pasha	R20EP003
25	Aishwarya s Radder	R20EN170
26	Ravitejareddyboilla	R20EN055
27	M.Naveen	R20EN080
28	Ranjith GB	R2021074
29	Vishwas N R	R20EN233
30	Joyson	R20EN196
31	Moulidas R	R20EN203
32	PR ASHWIN RAO	R20EP039
33	Mutturaj	R20EN204
34	Pavuluri.Yeswanth sai	R20EN097
35	Chethana.s	R20EP014
36	Nisarga.M	R20EN093
37	CHAITRA M S	R20EP010
38	Ganga H Yadahalli	R20EP023
39	Rebecca Rodrigues	R20EM076
40	Aryan M Thacker	R20EP007
41	Mallikarjun	R20EF184
42	Nishant N	R20EP038
43	L.Sai Gowtham Red Jy	R20EN065
44	Aashish R Goudar	R20EP001





Sl. No	Name	SRN
45	Kumar Swamy Naik O	R20EP075
46	Vachan Arun Hanamanal	R20EP091
47	VISHAL V	R20EP095
48	Subrat bakliwal	R20EF165
49	Ullias BM	R20EP089
50	YM Shafeeq Ahmed	R20EM102
51	Asra shamshad	R20EN175
52	Jhanhavi M Kashyap	R20EN195
53	Sharon Maria SP	R20EP083
54	Rishav	R20ef457
55	Arun narayana adidravida	R20EF170
56	Kavya B S	R17PEC12
57	Rohan Lakshman	R17ec256
58	Zainab Mullur	R20EP057
59	U.Nanda kumar	R20EN111
60	Harshith R	R20EP071
61	Pavan	R20EN096
62	SUGURESH	R20EP086
63	L vamshi	R20EF182
64	L vamshi	R20EF182
65	Ananya s	R20EP059
66	Sagar Nandikol	R20EN053
67	Shenoy Keshavakshay R	R20CS818
68	Meghadarshini S	R20EM055
69	MANOJ GOWDA V	R20EM053
70	Ravi Shankar D	REVA00781
71	Rajshekar	R20EP040
72	Muppalla lakshmi divya	R20EN086
73	Sumrudh arikeri	R20EP042
74	Aishwarya T S	R20EP004
75	Harshika M	R20EN191
76	APEKSHA BHAT	R20EP006
77	Mahabalesh H	R20EP033
78	Vaibhav N	R20EP055
79	Manu N R	R20EN079
80	Pavuluri.Yeswanth sai	R20EN097
81	Keerthana M	R20EN062
82	Sumrudh arikeri	R20EP042
83	R Vamsidhar Reddy	R20EC106
84	Prajwal S	R20EN098
85	Aishwarya T S	R20EP004
86	U.Nandakumar	R29EN111
87	Balanagu satya siddhartha	R20EP009
88	Manoj kumar c	R20EN077
89	Prajwal. K.	R20EN099
90	Vinayak k angadi	R20EM097
91	Prashanth P	R20EN101
92	Aftab Pasha	R20EP003
93	Vishal	R20EP095



Sl. No	Name	SRN
94	Likhith raje urs N	R20EN200
95	Sneha.N	R20EN222
96	Vismay U R	R20EA052
97	Manjunath j s	R20EN076
98	Manjunath j s	R20EN076
99	Sunil D M	R20PEC25
100	Thrupti S	R20EN228
101	Aras Amruth.Raj Purushotham	R20EP061
102	Arpith M	R20EA007
103	Harsha	R20EN102
104	V. Akharsh Reddy	R20EA053
105	Deepak N	R20EP019
106	AMMINENI VARSHITHA BHASKAR	R20EA006
107	Chiraag S	R20EP016
108	Soumyalatha Naveen	-
109	Sharath D M	R20EM084
110	Ranjan.N	R20EN109
111	Kavya Baiju	R20EM051
112	Vandana N	R20EP056
113	Jhanhavi M Kashyap	R20EN195
114	Dommaraju Nitish varma	R20EA014
115	TEJ ASHWIN.J	R20EP050
116	Harshith R	R20EP071
117	Ravi teja	R20EN070
118	U . Nanda Kumar	R20EN111
119	PALLAVI R C	R19EE835
120	Pooja	R19CS834
121	Ullas BM	R20EP089
122	Visbal karthik.V	R18ee176
123	Ajay kumar M J	R20EF169
124	Rakesh B Choudhary	R18EE121
125	Basavaraj	R19EE811
126	Aashish R Goudar	R20EP001
127	JOYDEEP SAHOO	R19EE823
128	Sanjana K Hulsure	R19EE100
129	Karanam Sharath Kumar	R20EP031
130	Sharath D M	R20EM084
131	Raja Kumar Rajak	R19EE839
132	Vinay Kumar	R18CS461
133	G Navya	R18cs131
134	Shilpa. R	R18CS396
135	AISHWARYA GIRISH MENON	R18CS026
136	Karanam Nikshitha	R20EN059
137	KIRANA G Y	R18CS181
138	Prajwal.G	R19CS236
139	Shaik mohammed tahid	R20EN220
140	SRIVARDHAN S DESHPANDE	R20EF164
141	Kalidasan	R19EE824
142	Manoj S	R20EC078



Sl. No	Name	SRN
143	Sathya Raj	R26EE219
144	KouamÃ© Yann Olivier	R20PEC14
145	Lohith	R20EP011
146	Shashank	R20EM085
147	Ravi Shankar D	REVA00781
148	Ganga H Yadahalli	R20EP023
149	Navita	R19CS829
150	Vinayak k angadi	R20EM097
151	Vishwas A	R20EM101
152	Srishti	R20EP085
153	Maithreyi.c	R20ENO73
154	SRIVARDHAN S DESHPANDE	R20EF164
155	Shriharinayaka P	R20EM086
156	Raghunandan KY	R20EN105
157	SURYA K N	R16EE178
158	Noor nabila	R20EM064
159	Dr. Veena K.N	REVA01020
160	Charith	R20EP082

Director Signature



*[Handwritten Signature]*  
29/05/21



**REVA**  
**UNIVERSITY**

Bengaluru, India

**CSI Club Activity- Talk on "CSI Sensitization & Technology Awareness "**

About the talk	<b>CSI Club Activity- Talk on "CSI Sensitization &amp; Technology Awareness "</b>
Organized By	CSI Club, School of Computing and Information Technology
Date of talk	8 <sup>th</sup> August 2020 Timings : 10:00AM to 11:00AM
Objectives	The objectives of the talk were to educate students about, <ol style="list-style-type: none"><li>1. What is CSI</li><li>2. Benefits of CSI membership</li><li>3. New technologies</li><li>4. Practical Applications of new Technologies</li></ol>
Overview	Prof Vani K welcomed the gathering. Dr S S Manvi and Dr. Ashwin Kumar U M addressed the gathering. Dr. Mallikarjun M Kodabagi, Professor, School of Computing & Information Technology, REVA University delivered talk on " <b>CSI Sensitization &amp; Technology Awareness</b> ". The event was concluded with vote of thanks by Prof. Anooja Ali.
Resource Person	Dr. Mallikarjun M Kodabagi, Professor, School of Computing & Information Technology, REVA University
Participants	66 students from School of Computing & Information Technology.
Faculty Coordinators	Dr. Mallikarjun M Kodabagi, Prof. Anooja Ali, Prof. Vani K

**Photos:**



**CSI Club Sensitization and Technology Awareness Session**  
UNIVERSITY

Established under the Section 2(F) of the UCA Act, 1956  
Approved by AICTE, COE and BCI, New Delhi.

**School of Computing & Information Technology**

**CSI Club**  
Organizes – Talk on  
**CSI Sensitization and Technology Awareness**

Date: 08-08-2020  
Time: 10 am to 11 am

Leave

Faculty Incharges:  
Dr. Mallikarjun M Kodabagi  
Prof. Anooja Ali  
Prof. Vani K



Image 1: Inaugural Session of CSI event

**CSI Club Sensitization and Technology Awareness Session**  
UNIVERSITY

Established under the Section 2(F) of the UCA Act, 1956  
Approved by AICTE, COE and BCI, New Delhi.

**Computer Society of India(CSI)**

**School of Computing and Information Technology**

**Dr. Mallikarjun M. Kodabagi**  
Professor, School of CIT  
Deputy Director(IQAC)

08/08/2020

Leave

Image 2: Introduction on CSI session



**CSI Club Sensitization and Technology Awareness Session**

**Life Time Membership**

**Fee**

15% Membership Discount on Life Membership of CSI

CSI is offering 15% discount on Individual Life Membership fee to support the IT community in this difficult time of COVID-19 pandemic.

The discounted individual life membership fee will be Rs. 8500 + Rs. 1530 (18% GST ) = Rs. 10030/-.

The members will be eligible for all privileges of a CSI member along with soft copy of CSI Communications and other CSI publications

Image 3: Detailing on CSI membership

**Coordinators:**

Dr. Mallikarjun M Kodabagi,  
Prof. Anooja Ali,  
Prof. Vani K

**Director**

Dr. Sunilkumar S. Manvi  
School of C&IT  
REVA University



**REVA UNIVERSITY**  
**SCHOOL OF COMPUTING ANF INFORMATION TECHNOLOFY**  
**Technical Talk on "CSI Sensitization & Technology Awareness "**

SI NO	SRN	Name
1	R18CS539	Vishakh V Badami
2	R18CS541	Waheed Khan
3	R18CS506	Avi Coomar
4	R18CS512	G HARSHAVARDHAN
5	R18CS537	Vineet Negi
6	R18CS363	Pavan Kumar yadav s
7	R18cs259	Noel john correya
8	R18CS261	Nossam Jayanth Kumar Reddy
9	R19CS345	Svivansh RM
10	R18CS418	Viveksreerama
11	R18CS430	Surendrabalaji
12	R18CS472	Yadvika jayam.N
13	R19CS858	VENKATESH S
14	R18CS147	Gorava Praveenkumar
15	R18CS300	Prashant Rathod
16	R18cs479	Zakiya Shabnam H R
17	R18CS480	Zeenat Kausar
18	R18CS494	Rajiv Bhandary
19	R18CS504	AMAN DUBEY
20	R18CS518	KOMAL N
21	R18CS523	Pruthvitha.R
22	R18CS512	Sneha R
23	R19CS855	Varshitha B S
24	R18CS497	Sindhu Srinivas
25	R18CS501	ADNAN AZAM
26	R18CS528	Sahana H S
27	R18CS490	Pramodhini. P
28	R18CS508	C H KUSHAL PAVAN
29	R18cs531	Shashhank G
30	R19CS852	Supriya.s
31	R17CS404	SOHAM KISHOR MISAL
32	R18CS134	G Harish Naidu
33	R18CS184	KOMMI.MANOHAR
34	R18CS189	Kaushik R
35	R18cs015	Abhishek papanur
36	R18CS017	Abhya Singh
37	R18CS065	ASHA B
38	R18CS066	Ashish Sood
39	R19CS844	Sharath CP
40	R18CS266	M P S S CHAKRADHAR



**REVA**  
**UNIVERSITY**

Bengaluru, India

41	R18CS352	Sachin Ashok Basavaraddi
42	R18CS356	Sai Chandan
43	R18CS486	L SAILENDER REDDY
44	R18cs505	Amith k
45	R18CS511	Dileep Kumar Reddy J K
46	R18CS524	R.Lisha
47	R18cs527	Sachin
48	R18CS534	Syed Hasnain
49	R19cs854	Tharunkumar S
50	R18CS077	B. Krishna Vamsi
51	R18CS105	Rehmanali M Dauva
52	R16CS474	VIKAS B KATTIMANI
53	R18CS035	Ambati Vamsidhar Reddy
54	R18CS088	Chaitra AC
55	R18CS102	Yamini Priya dk
56	R16CS543	PRATYUSH RAJ SINHA
57	R17cs293	Rohith varma
58	R19CS801	Aakash S
59	R18cs510	Dhanush M
60	R18CS519	K.yaswanth reddy
61	R18cs540	Vivek v tamashetti
62	R18cs499	Ujjwal kumar
63	R18CS521	Marthala Bindu
64	R18CS387	Sharanya M
65	R18CS451	VAKATI SAI KALYAN
66	R19Cs857	Venkatesh R

Director signature

School of Computer Science and Engineering,  
REVA University  
Rukmini Knowledge Park, Kaligandahalli,  
Yelahanka, Bengaluru-560 084.





**REVA**  
**UNIVERSITY**

Bengaluru, India

**Report of WEBINAR on “Why, What and How of AI” is Organised by School of Computing & Information Technology from the Computational Intelligence Club.**

**Coordinators: Dr.Udaya Rani V, Prof. Sarvamangala D.R, Prof. Priyanka Bharathi, Prof. Sohara Banu**

**Venue:** Virtual Talk Through TEAMS App

**Date:** 29/08/2020 from 11.30am to 12.30pm.

**Participants:** B. Tech Students of ECE, EEE and CSE (31 students have attended ).

Computational Intelligence: Cognitive Intelligence, is a part of Artificial Intelligence. It mainly covers the technology and tools that allow our apps, websites and bots to see, hear, speak and understand the needs of the user through Natural language. They are they AI apps that allow machines to learn their users’ language. AI, for its part, is a much wider concept that includes technology and innovations such as robotics, Machine Learning, Deep Learning, Neural Networks, NLP.

**Speaker Profile: Mr. MUHAMMED HAMZAH, Senior Software Engineer, Global Logic.**

**Profile**

2.7+ years demonstrated experience in innovation channel across AI/ML space. Garnered experience in leading/managing teams and delivered crowning POCs resulting in new customer wins

**Educational Background = B.Tech (CSE) with Distinction.**

**Achievements**

- THE LEAGUE EXTRAORDINAIRE AWARD 2019-20
- INDIVIDUAL EXCELLENCE AWARD Q2 FY 19-20
- OUT OF THE BOX AWARD - GL KUDOS 19-20
- GL SAMARITANS AWARD - GL KUDOS 19-20
- FACILITATED FOR INNOVATION@GL FOR EMAIL STO
- FIRST RUNNER'S UP- 30HACKS HACKATHON (SOUTH INDIA REGION) ROCKSTAR ROOKIE FY 18-19
- SPOTLIGHT OF THE MONTH AUG'18

**Experience :**

SENIOR SOFTWARE ENGINEER GLOBALLOGIC | OCT 2017 - PRESENT (TRAINEE-SSE)

Handled new innovation projects for the centre which resulted in new customer wins. Developed 7+ POCs in FY19-20 and undertook multiple research projects revolving around

the AI/ML space, along with regular project work. Multiple POCs got into product roadmap of some reputed clients. Designed and developed APIs for a digital marketing client upon migration of legacy system to new tech stack. 3 major AI/ML POCs are the current highlights of GlobalLogic's Bangalore Customer Experience Centre.

The Technical Talk was delivered on following topics:

- Introduction to Cognitive Computing.
- Introduction to AI and ML.
- Discussion on Implementation of Data Science based projects.

On behalf of School of Computing & Information Technology we would like to thank our Honorable Chancellor **Dr. P. Shyama Raju**, Vice Chancellor Dr. K. Mallikharjuna Babu, Registrar **Dr. M. Dhanamjaya**, Dean-placement, Training and Planning **Dr. N. Ramesh** for their continuous support.

We extend our special thanks to our beloved Director **Dr. Sunil Kumar S Manvi** and Assistant Director **Dr. Ashwin Kumar U M** for their continuous support, encouragement and motivation.

### Few Snaps of Technical talk

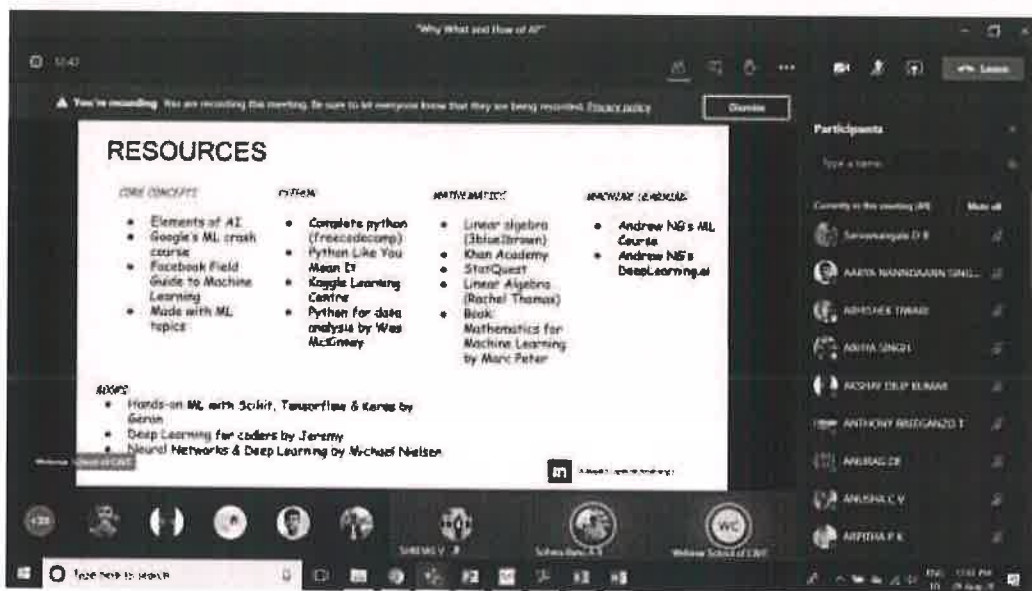
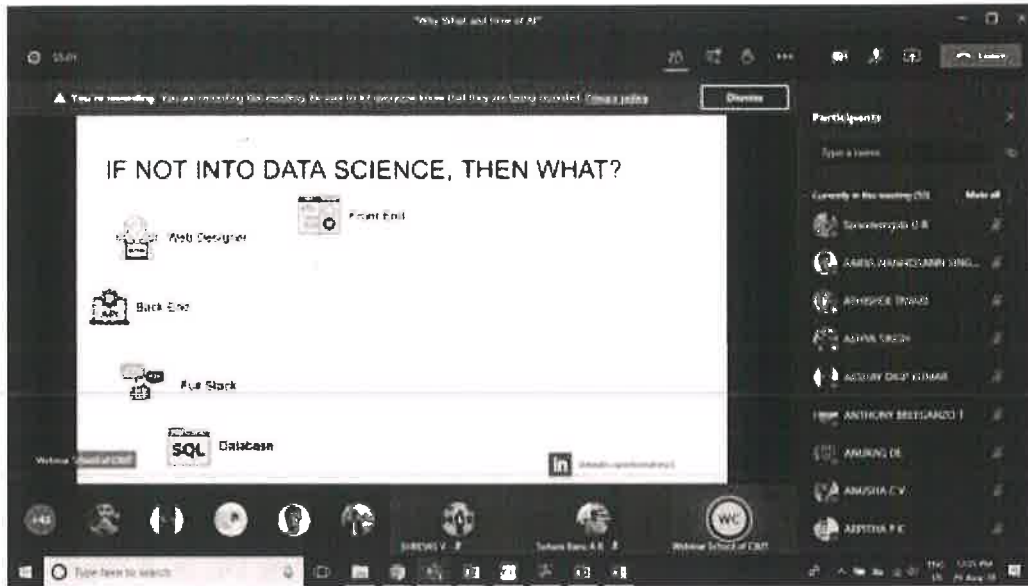
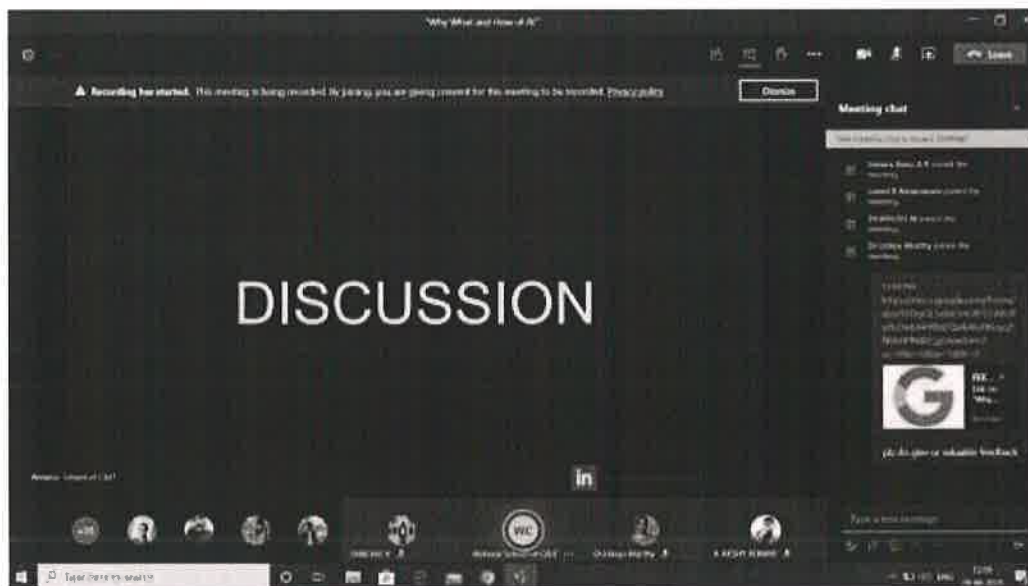

Image 1: Demo by Resource person



**Image 2: Screen sharing by resource Person on DataScience**



**Image 3: Discussion in progress**



REVA UNIVERSITY

SCHOOL OF COMPUTING ANF INFORMATION TECHNOLOFY

Technical Talk on "Why, What and How of AI " Attendance list

SI No	Date	Name of the Student	SRN of the Student	Semester
1	29/8/2020	Ashwini R	R17CS001	5
2	29/8/2020	Pavansai	R17CS174	7
3	29/8/2020	Ashwinth Singh P	R17CS055	7
4	29/8/2020	AKSHAY DILIP KUMAR	R18EE012	5
5	29/8/2020	Lekhana J	R17CS489	7
6	29/8/2020	MUHAMMAD MAAHIN KHAN	R18EE088	5
7	29/8/2020	Shreyas V	R16cs395	7
8	29/8/2020	Pradeep rs	R18cs291	5
9	29/8/2020	Venkat Biyyapu	R18CS455	5
10	29/8/2020	Ankita Singh	R18CS045	5th
11	29/8/2020	Sweta Gupta	R18CS434	5
12	29/8/2020	Arpitha P K	R18CS062	5
13	29/8/2020	Revanth Horatti	R17CS519	7
14	29/8/2020	Keertheswaran	R19CS156	3
15	29/8/2020	Manasa CH	R17CS221	7
16	29/8/2020	Kusuma D	R17cs204	7
17	29/8/2020	Dhanush S N	r17cs179	7
18	29/8/2020	Anusha CV	R18CS054	5
19	29/8/2020	Tejashree AJ	R18CS439	5
20	29/8/2020	Pallavi	R18CS272	5 th
21	29/8/2020	A SANDHYA	R19CS002	3
22	29/8/2020	Mukul B	R17CS237	7
23	29/8/2020	Akshy Kumar	R19CS140	3rd
24	29/8/2020	Anurag De	R19CS037	3
25	29/8/2020	AKSHAY DILIP KUMAR	R18EE012	5TH
26	29/8/2020	Meghana PG	R17CS232	7
27	29/8/2020	N.Varshitha	R19CS205	3
28	29/8/2020	Suhas Reddy B R	R19CS336	3
29	29/8/2020	Jyotsna BN	R19CS399	3
30	29/8/2020	Meghana PG	R17CS232	7
31	29/8/2020	Aarya Nanndaann Singh M N	R19CS007	3

Director, signature

School of Computer Science and Engineering  
REVA University  
Rukmini Knowledge Park, Kattigenahalli,  
Yelahanka, Bengaluru-560 064.





## Report on

### “Technical Talk On Introduction to GitHub”

Organized by School of Computer Science & Engineering,

Date: 27<sup>th</sup> March, 2021

The School of Computer Science & Engineering organized and hosted a technical talk on “Introduction to GitHub” at REVA University. The talk was targeted for the undergraduate students of 1<sup>st</sup> year. Approximately 266 students participated in this talk.

The talk was delivered by **one of our alumni Ms. Neha Yadav** eminent Speaker from Xoriant Solutions Pvt.Ltd, Bengaluru. The session was delivered from 10:00 am to 11:30 am. The talk was focused on the following key points:

- What is GitHub?
- How does one use GitHub?
- What are issues and pull requests?
- How do you create a branch and a commit?
- How do you use GitHub Pages?

And when the students are done with the talk, they will be able to:

- Communicate in issues
- Manage notifications
- Create branches
- Make commits
- Introduce changes with pull requests
- Deploy a web page to GitHub pages

Finally, the speaker answered to the queries of the students regarding GitHub and latest technologies which are required to get into the reputed companies.

**Speaker:** Ms. Neha Yadav, Associate Software Engineer, Xoriant Solutions Pvt.Ltd, Koramangala, Bengaluru.

**Faculty Coordinators:** Dr. P.V. Bhaskar Reddy, Prof. Shilpa N R, Mr. Palanivel

E-Banner of the session:

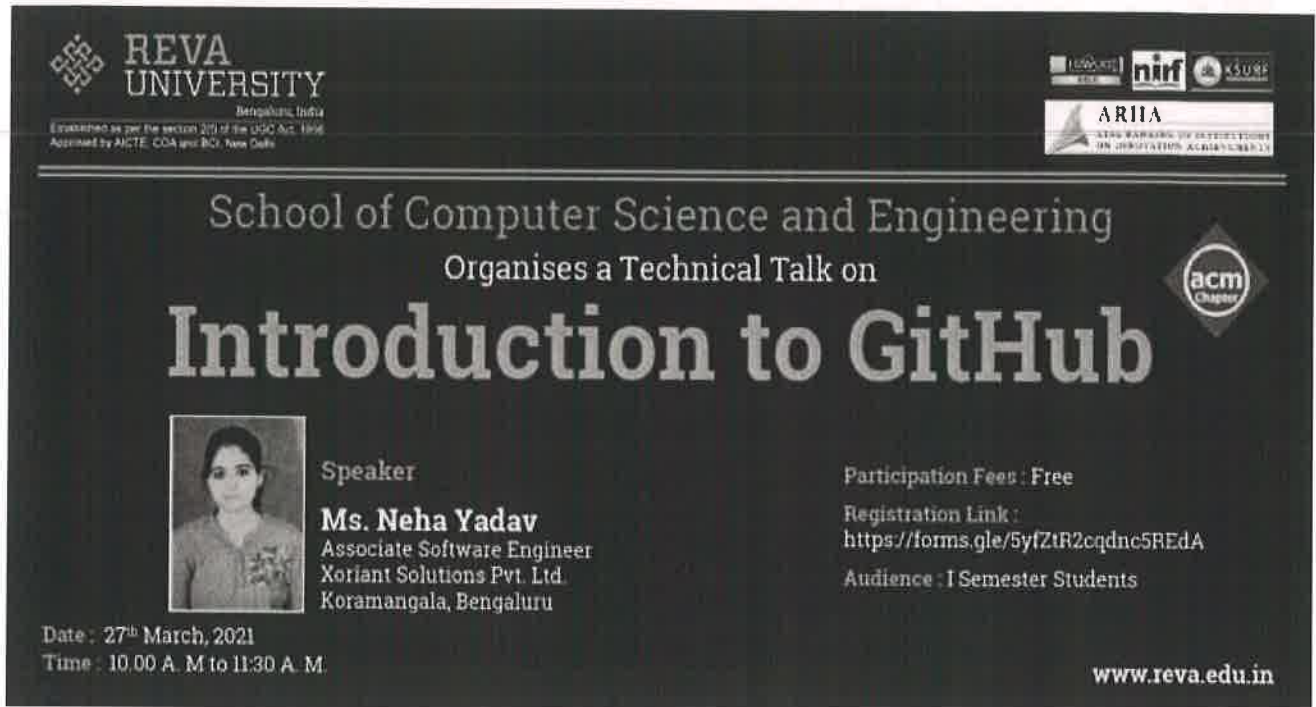

The banner is for a technical talk titled "Introduction to GitHub" organized by the School of Computer Science and Engineering at REVA University. The speaker is Ms. Neha Yadav, an Associate Software Engineer at Xoriant Solutions Pvt. Ltd. The talk is scheduled for 27th March, 2021, from 10:00 A.M. to 11:30 A.M. Participation is free, and the audience is limited to I Semester Students. The banner includes logos for REVA University, ARIIA, and ACM Chapter, along with accreditation details.

**REVA UNIVERSITY**  
Bengaluru, India  
Established as per the section 20 of the UGC Act, 1956  
Approved by AICTE, COA and BCI, New Delhi

**ARIIA**  
ACADEMIC RISK INSTITUTE OF INDIAN ASSOCIATION OF UNIVERSITY

**acm**  
Chapter

School of Computer Science and Engineering  
Organises a Technical Talk on

# Introduction to GitHub

**Speaker**  
**Ms. Neha Yadav**  
Associate Software Engineer  
Xoriant Solutions Pvt. Ltd.  
Koramangala, Bengaluru

Participation Fees : Free  
Registration Link :  
<https://forms.gle/5yfZtR2cqdnC5REdA>  
Audience : I Semester Students

Date : 27<sup>th</sup> March, 2021  
Time : 10.00 A. M to 11:30 A. M.

[www.reva.edu.in](http://www.reva.edu.in)

**Following is the link to register for the talk:**

**<https://forms.gle/5yfZtR2cqdnC5REdA>**

**Following is the link to attend the talk:**

**<https://bit.ly/3dc9cNt>**

Some of the snapshots of the session are as below:



Snapshot1: welcome Address

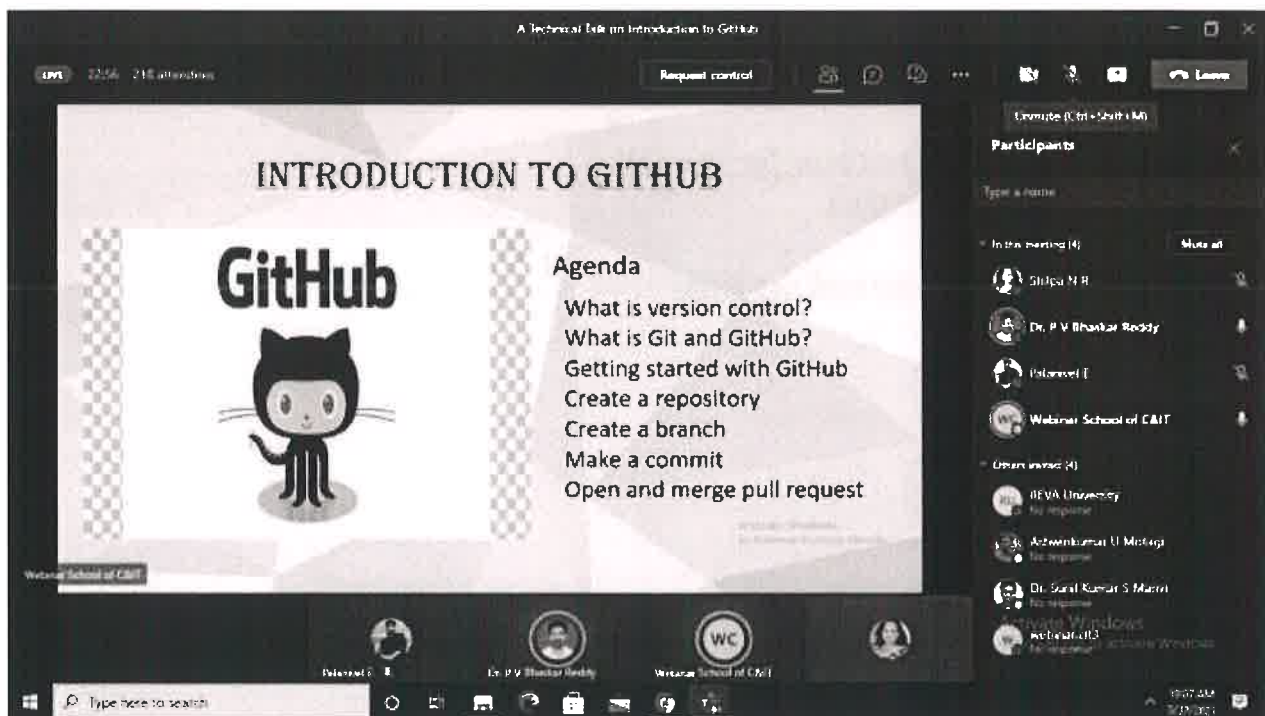

Snapshot2: Resource person Started the session

A Technical Talk on Introduction to GitLab

24:43 219 attendees

Request control

## THE NEED OF VERSION CONTROL

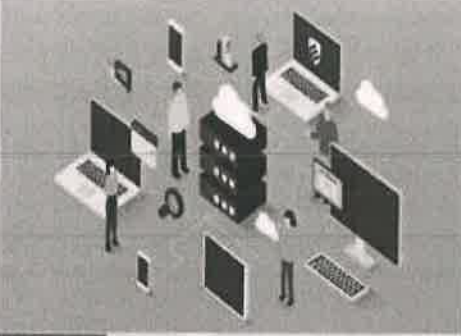

Problems encountered when multiple developers working on same project :-

1. Collaboration
2. Storing
3. Restoring previous versions
4. Figuring out what happened?
5. Backup

Webinar School of CAIT

Participants

Type a name

In the meeting (4)

- Shruti H R
- Dr. P. V. Bhaskar Reddy
- Adarsh D
- Webinar School of CAIT

Others invited (0)

- REVA University
- Adarsh D Malaga
- Dr. Sunil Kumar S Murali
- Webinar School of CAIT

19:01 AM 5/27/2021

Snapshot3: giving talk on need of version control

A Technical Talk on Introduction to GitLab

31:35 273 attendees

Request control

## HOW VERSION CONTROL WORKS?

### Centralized version control



Server

REPOSITORY

WORKING COPY

WORKING COPY

WORKING COPY

Workstation/PC #1 Workstation/PC #2 Workstation/PC #3

Meeting chat

Dr. P. V. Bhaskar Reddy and 4 others were invited to the meeting.

Tuesday

Tuesday 2:46 PM Meeting started.

Adarsh D Malaga and Dr. Sunil Kumar S Murali were invited to the meeting.

Tuesday 4:12 PM Meeting ended. In 37m 27s.

Tuesday

4:44 AM Meeting started.

19:16 AM 5/27/2021





**REVA UNIVERSITY**  
**SCHOOL OF COMPUTER SCIENCE AND ENGINEERING**  
**Technical Talk on "Introduction to GitHub"**

Sl No.	Name	SRN
1	R SWASTHIK	R20EF132
2	Pradhumna	R20ef420
3	Sathisha .s	R20EF429
4	Mohammad Fawaz Beejady	R20EF414
5	G M YESHWANT	R20EF405
6	NIMISHA.N	R20EF120
7	Pranay D	R20EF403
8	Rhea M Thomas	R20EF136
9	Akandi Hari Prasad	R20EF447
10	Shyamali bharti	R20EF450
11	Rajiv Reddy	R20EF133
12	Raghu	R20EF116
13	Wamika. S	R20EF441
14	Deboraj Dutta	R20EF404
15	Pavan ganesh	R20EF123
16	Chandan M S	R20EF402
17	Vishal	R20EF440
18	Pavan Kalyan	R20EF138
19	Gauatm	R20EF122
20	R Nithish	R20EF371
21	Shashank P	R20EF148
22	Shekamoori Pavithra	R20EF151
23	Shaik Mohammad hussain	R20EF430
24	Saathvik	R20EF114
25	Neeyal D	R20EF103
26	Bhargavi Mathad	R20EF400
27	C SRI SRAVYA	R20EF115
28	S.manaswi	R20EF413
29	Shashank S Raichur	R20EF150
30	Avinash	R20EF287
31	Supriya ys	R20EF437
32	Harshitha SR	R20EF406
33	RAKSHA R Y	R20EF134
34	Saniya Roshan	R20EF142
35	RITESH	R20EF191
36	shreya mahida	R20EF154
37	LEAVING kalyan	R20EF304
38	G. Bhargav	Reva/2020/1601
39	Sowmya Sree T	R20EF162
40	Santi kumar	R20EF144
41	Humera Jabeen	R20EF180
42	Varsha kandoori	R20EF209
43	Monisha	R20EF311



Sl No.	Name	SRN
44	Shiva kumarR	R20EF325
45	Akshata Hiremath	R20EF395
46	Vishwanath sangayya vastrad	R20EF340
47	Jashmitha C G	R20EF178
48	Sathish V	R20EF194
49	U M LIKHITH	R20EF337
50	Yashaswini pg	R20EF341
51	Sangeethabk	R20EF141
52	SHIVA KUMAR A	R20EF153
53	Rajkumar	R20EF319
54	Likith gowda r	R20EF306
55	Shireen	R20EF52
56	Vishnu priya. R	R20EF216
57	Shreya raj	R20EF434
58	Ravi Teja C	R20EF051
59	Dhanush U	R20EF033
60	Dafedar firdose	R20EF025
61	Gangadhar	R20ET295
62	Basavaraj	R20EF289
63	Dharani dhar	R20EF048
64	BHOOMIKA km	R20EF291
65	Shreya Ganapati Hegde	R20EF433
66	hanamant subhas nakkaragundi	R20EF298
67	B.U.NAVYASHREE GUJJAR	R20EF398
68	Shalini H. M	R20EF2020
69	Prakruthi H	R20EF421
70	Pavan kumar k p	R20EF314
71	C Yogesh	R20EF175
72	ABHISHEK. H.A	R20ef393
73	Pavan	R20EF419
74	Amarnath prathap	R20EF422
75	Churanta Mondal	R20EF024
76	Mohit Kumar	R20ef310
77	SANTOSH	R20EF322
78	Vignesh Bollam	R20EF057
79	Hrushikesh	R20EF407
80	Manogna M S	R20EF087
81	Dheeraj R	R20EF034
82	HEMANTH P	R20EF063
83	ANKITH Shetty	R20EF396
84	Shashank H A	R20EF324
85	Archit Arya	R20EF013
86	Mule prudhvinath reddy	R20EF099
87	Kalvakolanu vijaysree	R20EF301
88	Madhu AS	R20EF084
89	Prajwal	R20EF126
90	Keerthana priya R	R20EF302
91	Mallikarjun	R20EF184
92	MEDA VEERENDRA CHARAN TEJ	R20EF091

Sl No.	Name	SRN
93	Shukrutha S	R20EF328
94	Akshay T	R20EF285
95	MOHAMMED REHAN	R20EF096
96	Gollur sankhyayana	R20EF038
97	Gopal	R20EF118
98	Shailesh	R20EF234
99	Meghana P Shetty	R20EF309
100	Dandamudi akhil	R20EF026
101	Nithin Raj Kalyani	R20EF109
102	Tausif Rizwan	R20EF203
103	Suman S	R20EF436
104	Abhishek Holla	R20EF282
105	Shreyas	R20EF327
106	Geetanjali Singh	R20EF297
107	Sahana D	R20EF427
108	Prateek	R20EF127
109	Manoj Kumar v	R20EF088
110	Darshan s	R20ef028
111	Mudiyam swetha	R20EF098
112	Nazneen Asif	R20EF102
113	Vishal Basawakumar Desai	R20EF213
114	Tarun Kumar A	R20EF336
115	SUHAS J R	R20EF198
116	Vishwas mn	R20EF217
117	Saurabh	R20EF323
118	Kusuma. G	R20EF082
119	Gadilinga reddy	R20EF117
120	Nandeesh P S	R20EF417
121	PRERAN ARYA G R	R20EF050
122	Sai Prasad C	R20EF321
123	Mayook vinod k	R20EF089
124	VIGNESH C G	R20EF439
125	Kadapa karim	R20EF071
126	MOHAMMAD ASHFAQ HUSSAIN	R20EF095
127	Lavanya R	R20EF083
128	K.Bhuvana	R20EF070
129	Dileep Chandru S	R20EF294
130	Bandhavva NM	R20EF399
131	M Abhishek	R20EF411
132	Ajay Kumar M J	R20EF169
133	SRIVARDHAN .S .DESHPANDE	R20EF164
134	Vamshi krishna T M	R20EF452
135	Sanjana Binoj	R20EF453
136	Hemanth j	R20EF299
137	Sandeep	R20EF428
138	Arunachalesha M Kembhavimath	R20EF397
139	Syed Khwaja Nawaz Junaidi	R20EF438
140	Lakshmi Prasad	R20EF409
141	KushalAchar	R20EF303



Sl No.	Name	SRN
142	Didonehal N Gowda	R20EF035
143	Shashank P	R20EF149
144	Shwetha V	R20EF156
145	Nithin.v.kumar	R20EF312
146	Srinidhi.R	R20EF163
147	Bhanu Priya	R20EF290
148	Preksha Praveen	R20EF318

Director Signature

27/05/21





REVA  
UNIVERSITY

Bengaluru, India

The School of Computing & IT  
Event Report on

**"Club Activity Talk on Augmented Reality " (28th Nov 2020)**

<b>About the Webinar</b>	<b>Augmented reality (AR)</b> is an interactive experience of a real-world environment where the objects that reside in the real world are enhanced by computer-generated perceptual information, sometimes across multiple sensory modalities, including visual, auditory, haptic, somato sensory and olfactory.
<b>Organized By</b>	School of Computing and Information Technology
<b>Date of Club Activity</b>	<b><u>(28th Nov 2020)</u></b>
<b>Convener</b>	<b>Dr. Sunilkumar S Manvi, Director, School of C&amp;IT.</b> <b>Dr. Ashwinkumar U M Professor &amp; Assistant Director, School of C&amp;IT</b>
<b>Organizing Chairs</b>	Kanaiya V Kanzaria, Dr. Shashidhar Babu
<b>CO-ORDINATORS</b>	Vinay Kumar Yerriswamy Sunil Manoli
<b>Targeted Audience</b>	students
<b>Resource Person(s)</b>	<b>Alon Grinshpoon</b> <b>Co-Founder and Chief Executive Officer at echoAR.</b>
<b>Brief Profile of the Resource Person (s)</b>	Alon is a Java native-speaker with countless hours of programming in Java, Android, Unity, C#, C and Bash. Alon loves to create AR/VR apps, GUI and graphically design applications, open-source programs and API integration alongside his experience and passion for cloud and computer communication networks. Alon received his MSc in Computer Science from Columbia University's School of Engineering and Applied Science specializing in computer graphics, virtual and augmented reality, and human-computer interaction. Alon wrote his thesis on an Augmented Reality Guidance System for Endovascular Surgery advised by Prof. Steven K. Feiner.



	<p>Alon received his BSc as a double major in Computer Science and Electrical and Electronic Engineering from Tel Aviv University specializing in software engineering, computer networks, and cyber-security.</p> <p>During his studies, Alon served as a graduate researcher at the Computer Graphics and User Interfaces Laboratory of Columbia University. Alon also served as a research assistant and teaching assistant in the fields of computer networks and distributed cloud.</p>
<b>No. of Participants</b>	270
	<p>The event started with the Online Inauguration by our School Director Dr. Sunil Kumar S Manvi, and School assistant director Dr. Ashwin Kumar U M . Kanaiya V Kanzaria who welcomed and addressed the event on <u>"Augmented Reality"</u> The briefing about the Technical talk was done by Dr.Shashidhar Babu.</p>
Session Photos	





REVA  
UNIVERSITY

Bengaluru, India

# WebXR

Hit test sample

 [github.com/immersive-web](https://github.com/immersive-web)

 Experts

keshavan S

LIVE



Type here to search



LIVE

38:33



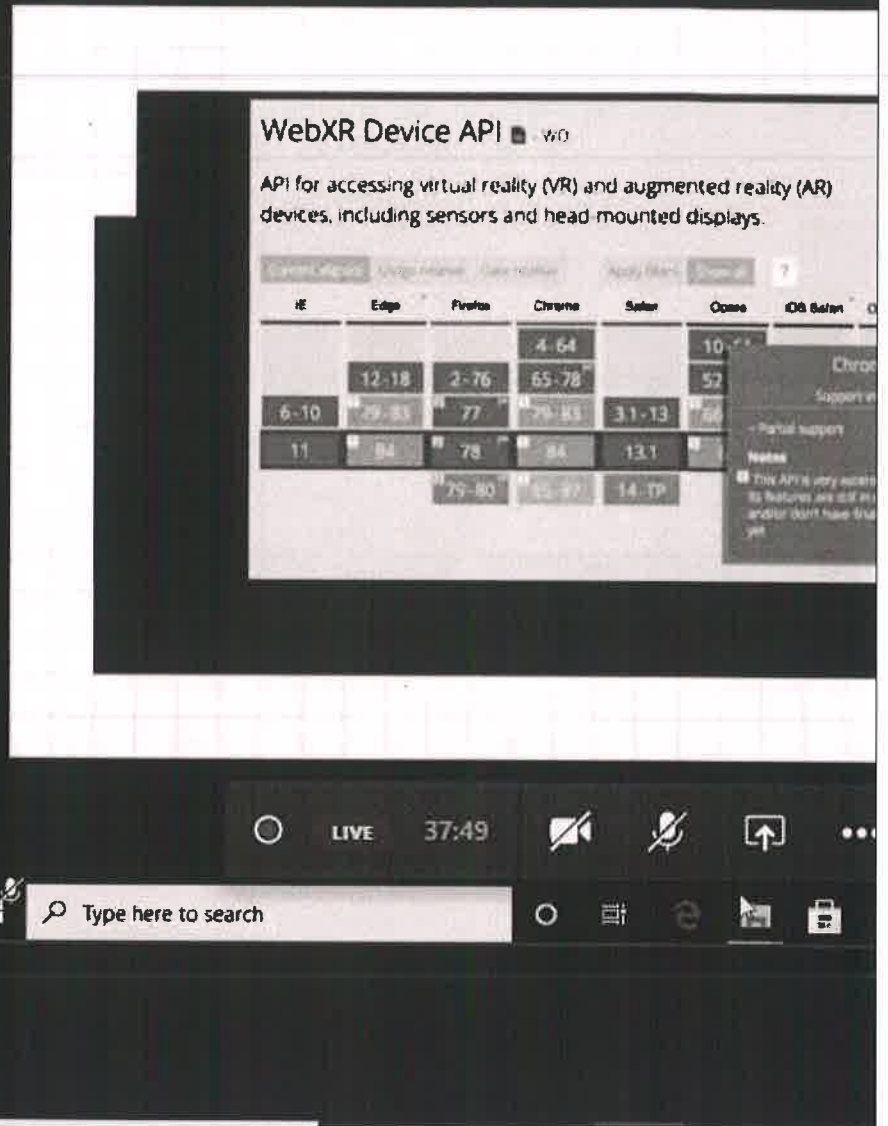

Snapshot: Resource Personce giving an introduction to Augmented Reality.

**Feedback from Participants**

All the participants expressed satisfaction over the conduction of the Club Activity Talk and the contents delivered.



**REVA UNIVERSITY**

**SCHOOL OF COMPUTING ANF INFORMATION TECHNOLOFY**

**Technical Talk on "Augmented Reality " Attendance list**

Sl No	Participant ID	Name
1	R18CS254@cit.reva.edu.in	NEELAKANTH S
2	bhaskarreddy.pv@reva.edu.in	Dr. P V Bhaskar Reddy
3	bhulakshmi.d@reva.edu.in	D Bhulakshmi
4	farooque.azam@reva.edu.in	Farooque Azam
5	k.tanuja@reva.edu.in	Tanuja K
6	kanaiya.vk@reva.edu.in	Kanaiya V Kanzaria
7	keshava.s@reva.edu.in	keshavan S
8	kiran.m@reva.edu.in	Kiran M
9	R16CS359@cit.reva.edu.in	SAI KRISHNA R
10	R17CS072@cit.reva.edu.in	BATTU VENU
11	R17CS146@cit.reva.edu.in	HARIBABU T
12	R17CS269@cit.reva.edu.in	Nikhil Kumar M
13	R17CS295@cit.reva.edu.in	PRADEEP S
14	R17CS305@cit.reva.edu.in	PRATYUSH SINGH
15	R17CS315@cit.reva.edu.in	RAGHAV JOSHY
16	R18CS003@cit.reva.edu.in	ABDUL MATEEN MULLUR ABDUL MATEEN MULLUR
17	R18CS006@cit.reva.edu.in	ABHINAV ANAND
18	R18CS008@cit.reva.edu.in	ABHISHEK DUNDAGI ABHISHEK DUNDAGI
19	R18CS020@cit.reva.edu.in	ADITYA KUMAR
20	R18CS021@cit.reva.edu.in	ADITYA KUMAR PANDEY ADITYA KUMAR PANDEY
21	R18CS031@cit.reva.edu.in	ALOK BHUSANUR ALOK BHUSANUR
22	R18CS041@cit.reva.edu.in	ANIL KUMAR G JANIL KUMAR G J
23	R18CS049@cit.reva.edu.in	ANSHUL PRAKASH ANSHUL PRAKASH
24	R18CS065@cit.reva.edu.in	ASHA B ASHA B
25	R18CS088@cit.reva.edu.in	CHAITRA A C CHAITRA A C
26	R18CS101@cit.reva.edu.in	CHIRAG VIJAY CHIRAG VIJAY
27	R18CS108@cit.reva.edu.in	DEEKSHA H KOTTARY DEEKSHA H KOTTARY
28	R18CS109@cit.reva.edu.in	DEEP VASHISTH DEEP VASHISTH
29	R18CS112@cit.reva.edu.in	DEVALLA SHREE ADITHYA DEVALLA SHREE ADITHYA
30	R18CS117@cit.reva.edu.in	DHRUTHIK U DHRUTHIK U
31	R18CS119@cit.reva.edu.in	DINESH B DINESH B
32	R18CS122@cit.reva.edu.in	DIVYANSHI PATHAK DIVYANSHI PATHAK
33	R18CS172@cit.reva.edu.in	KARTHIKESHWAR KARTHIKESHWAR
34	R18CS181@cit.reva.edu.in	KIRANA G Y KIRANA G Y
35	R18CS192@cit.reva.edu.in	KUMAR ABHISHEK KUMAR ABHISHEK
36	R18CS198@cit.reva.edu.in	LAEEQULLAH KHAN LAEEQULLAH KHAN
37	R18CS201@cit.reva.edu.in	LAVANYA LAVANYA
38	R18CS212@cit.reva.edu.in	MANASA M A MANASA M A
39	R18CS222@cit.reva.edu.in	MD MAHEBOOB MD MAHEBOOB
40	R18CS230@cit.reva.edu.in	MOHAMMED FAHAD V K MOHAMMED FAHAD V K
41	R18CS240@cit.reva.edu.in	N RAKSHA N RAKSHA
42	R18CS261@cit.reva.edu.in	NOSSAM JAYANTH KUMAR REDDY NOSSAM JAYANTH KUMAR REDDY
43	R18CS272@cit.reva.edu.in	PALLAVI H A PALLAVI H A
44	R18CS291@cit.reva.edu.in	PRADEEP R S PRADEEP R S
45	R18CS299@cit.reva.edu.in	PRANSHU JHA
46	R18CS317@cit.reva.edu.in	RAGHAVENDRA A RAGHAVENDRA A
47	R18CS338@cit.reva.edu.in	ROSHINI R ROSHINI R
48	R18CS395@cit.reva.edu.in	SHILPA SHILPA

Sl No	Participant ID	Name
49	R18CS399@cit.reva.edu.in	SHIVANI SAHA SHIVANI SAHA
50	R18CS405@cit.reva.edu.in	SHRADHA B KABA SHRADHA B KABA
51	R18CS416@cit.reva.edu.in	SREE HARI V SREE HARI V
52	R18CS503@cit.reva.edu.in	AKSHAY H M
53	R18CS528@cit.reva.edu.in	SAHANA H S SAHANA H S
54	R18CS531@cit.reva.edu.in	SHASHANK G G
55	R18CS533@cit.reva.edu.in	SPANDANA H M SPANDANA H M
56	R18CS541@cit.reva.edu.in	WAHEED KHAN M WAHEED KHAN M
57	R18CS542@cit.reva.edu.in	BHAVANA Y M BHAVANA Y M
58	R19CI001@cit.reva.edu.in	VIGNESH KUMAR
59	R19CI015@cit.reva.edu.in	CHANDANA M
60	R19CI016@cit.reva.edu.in	D PRAVEEN
61	R19CI017@cit.reva.edu.in	DARSHAN N
62	R19CI021@cit.reva.edu.in	DHRUVA DODDAMANI
63	R19CI023@cit.reva.edu.in	GIRIDHAR RAO
64	R19CI039@cit.reva.edu.in	SRI CHANDAN REDDY K
65	R19CI046@cit.reva.edu.in	MALLAYYA MATHAPATI
66	R19CI052@cit.reva.edu.in	MEKA SIVA KRISHNA TEJA
67	R19CI057@cit.reva.edu.in	NIHARIKA CHINNAPPANNAGARI
68	R19CI060@cit.reva.edu.in	ADARSHA V S
69	R19CI072@cit.reva.edu.in	MANGESH MANGESH.
70	R19CI097@cit.reva.edu.in	SHUBHAM PRATAP SINGH
71	R19CI116@cit.reva.edu.in	ANWESHA SARANGI
72	R19CS006@cit.reva.edu.in	AAARON Y ISAAC
73	R19CS012@cit.reva.edu.in	ABHISHEK CHOUGULE
74	R19CS020@cit.reva.edu.in	AKASH HEGDE P
75	R19CS025@cit.reva.edu.in	NAVEEN KUMAR A
76	R19CS026@cit.reva.edu.in	AMENENI CHANDANA
77	R19CS031@cit.reva.edu.in	ANJALI N
78	R19CS035@cit.reva.edu.in	ANNEPU JAYA KRISHNA
79	R19CS037@cit.reva.edu.in	ANURAG DE
80	R19CS043@cit.reva.edu.in	ARUN JENSON
81	R19CS046@cit.reva.edu.in	ASHUTOSH MISHRA
82	R19CS049@cit.reva.edu.in	ATHRIYA SARAVANAN
83	R19CS051@cit.reva.edu.in	BALAPANOORSHARAB NAGA SRUJANA
84	R19CS069@cit.reva.edu.in	BOGI REDDY CHOWDESWAR REDDY
85	R19CS076@cit.reva.edu.in	CHANUKYA GOWDA K
86	R19CS086@cit.reva.edu.in	DADIREDDY SAI PRANEETH REDDY
87	R19CS091@cit.reva.edu.in	DEEPAK SINGH
88	R19CS099@cit.reva.edu.in	VAMSHI KRISHNA E
89	R19CS113@cit.reva.edu.in	GUNTAKA VAMSHI KOTI REDDY
90	R19CS115@cit.reva.edu.in	GUTHULA LALITHA MEGHANA
91	R19CS125@cit.reva.edu.in	HIMASHREE M
92	R19CS152@cit.reva.edu.in	KATTA KAMALA REETHIKA
93	R19CS155@cit.reva.edu.in	KEERTHANA B G
94	R19CS156@cit.reva.edu.in	KEERTHESWARAN M.D
95	R19CS159@cit.reva.edu.in	K SAICHARAN
96	R19CS168@cit.reva.edu.in	LAKKA SHYAM SUKUMAR
97	R19CS176@cit.reva.edu.in	MADHUBANTI CHAKRABORTY
98	R19CS184@cit.reva.edu.in	MANOJ KUMAR NARRAVULA
99	R19CS191@cit.reva.edu.in	SYED SAUBAN
100	R19CS197@cit.reva.edu.in	NIKHITH RAJU KONDURU
101	R19CS202@cit.reva.edu.in	MONIKA M
102	R19CS204@cit.reva.edu.in	MUSALAPPA GARI SAI TEJA
103	R19CS209@cit.reva.edu.in	NARALA GUNA VARDHAN REDDY



Sl No	Participant ID	Name
104	R19CS212@cit.reva.edu.in	NAVYA K L
105	R19CS214@cit.reva.edu.in	NEHA U G UG
106	R19CS216@cit.reva.edu.in	NETHRAVATHI PARWATGOUDAR
107	R19CS219@cit.reva.edu.in	NIKHILA S
108	R19CS224@cit.reva.edu.in	ORAMPATI LIKHITH KUMAR REDDY
109	R19CS226@cit.reva.edu.in	PALAKOLANU JAYA AVINASH REDDY
110	R19CS227@cit.reva.edu.in	PALUGULLA SAKETHRAM REDDY
111	R19CS228@cit.reva.edu.in	PANCHADARA SASIDHAR
112	R19CS229@cit.reva.edu.in	PARAMESH N
113	R19CS230@cit.reva.edu.in	PATAN SHARUK KHAN
114	R19CS232@cit.reva.edu.in	POLINENI MANOJ KUMAR
115	R19CS238@cit.reva.edu.in	PRIYANKA A
116	R19CS241@cit.reva.edu.in	R MOTHISH CHOWDARY
117	R19CS246@cit.reva.edu.in	RAMYA SHREE H
118	R19CS255@cit.reva.edu.in	NITESH KUMAR REDDY SYAMALA
119	R19CS256@cit.reva.edu.in	V VARSHA
120	R19CS262@cit.reva.edu.in	ROMPICHERLA SHAMANTH REDDY
121	R19CS291@cit.reva.edu.in	SANJAY KUMAR
122	R19CS318@cit.reva.edu.in	SRILAKSHMI ALLAM
123	R19CS322@cit.reva.edu.in	ADVAITH S SAKHARE
124	R19CS341@cit.reva.edu.in	SUSHMITHA M
125	R19CS355@cit.reva.edu.in	THUMMALURU GANGA LAKSHMI
126	R19CS387@cit.reva.edu.in	BHARGAVA JC
127	R19CS387@cit.reva.edu.in	BHARGAVA JC
128	R19CS387@cit.reva.edu.in	BHARGAVA JC
129	R19CS401@cit.reva.edu.in	KAVYA C
130	R19CS415@cit.reva.edu.in	MIRANJAN G
131	R19CS432@cit.reva.edu.in	SHASHIDHAR T S
132	R19CS437@cit.reva.edu.in	SPURTHI S R
133	R19CS445@cit.reva.edu.in	UGRNAM JAHNAVI ROYAL
134	R19CS447@cit.reva.edu.in	YALAMANCHILI PRABHU TEJA
135	R19CS458@cit.reva.edu.in	ALLA CHANDRA VAMSI KRISHNA
136	R19CS467@cit.reva.edu.in	THARUN D D
137	R19CS472@cit.reva.edu.in	APARAJITA APARAJITA
138	R19CS480@cit.reva.edu.in	AVI SHAH AVI SHAH
139	R19CS805@cit.reva.edu.in	ABHISHEK TIWARI
140	R19CS811@cit.reva.edu.in	BINDU B BINDU B
141	R19CS813@cit.reva.edu.in	DILIP U D DILIP U D
142	R19CS815@cit.reva.edu.in	JASBIR SINGH JASBIR SINGH
143	R19CS816@cit.reva.edu.in	K VEERESH K VEERESH
144	R19CS817@cit.reva.edu.in	KARTHIK H KARTHIK H
145	R19CS821@cit.reva.edu.in	LEELA K LEELA K
146	R19CS823@cit.reva.edu.in	LINGALA SAI GIRISH REDDY LINGALA SAI GIRISH REDDY
147	R19CS825@cit.reva.edu.in	MANJESH N MANJESH N
148	R19CS826@cit.reva.edu.in	MANOJ KUMAR N MANOJ KUMAR N
149	R19CS828@cit.reva.edu.in	NAVEEN M NAVEEN M
150	R19CS829@cit.reva.edu.in	NAVITA NAVITA
151	R19CS830@cit.reva.edu.in	NIKHIL CHANDRASHEKHAR BENAL NIKHIL CHANDRASHEKHAR BENAL
152	R19CS832@cit.reva.edu.in	NIRMALA M NIRMALA M
153	R19CS833@cit.reva.edu.in	POKA KRISHNA KAMAL POKA KRISHNA KAMAL
154	R19CS834@cit.reva.edu.in	POOJA POOJA
155	R19CS839@cit.reva.edu.in	PUNITH K PUNITH K
156	R19CS842@cit.reva.edu.in	SAMUEL NITESH JOHN SAMUEL NITESH JOHN
157	R19CS846@cit.reva.edu.in	SHIVARAJU C S SHIVARAJU C S





**Report of Technical Talk on “Microsoft Dynamics AX Platform”**  
**Organised by School of Computing & Information Technology from**  
**Microsoft Developers Club**

**Coordinators:** Dr. Amuthabala, Prof. Mallikarjun M, Prof. Thirumagal

**Venue:** Virtual Talk Through Microsoft Teams

**Date:** 27/11/2020 from 3pm to 4pm.

**Participants:** B. Tech 3<sup>rd</sup>, 5<sup>th</sup> & 7<sup>th</sup> Semester Students (84 students have attended)

**Microsoft Dynamics AX:** It is one of the Microsoft's enterprise resource planning software products. It is part of the Microsoft Dynamics family. In 2018, its thick-client interface was removed and the web product was rebranded as Microsoft Dynamics 365 for Finance and Operations as a part of Microsoft's Dynamics 365 suite. The Microsoft Dynamics AX software comprises four major components: The Database Server, a database that stores the Microsoft Dynamics AX data, The File Server, a folder containing the Microsoft Dynamics AX application files (in AX2012 application files are stored in the database), The Application Object Server(s) (AOS), a service that controls all aspects of Microsoft Dynamics AX's operation, The Client(s), the actual user interface into Microsoft Dynamics AX.

The Technical Talk was delivered on following topics:

- Introduction to Microsoft Dynamics AX platform
- Similar Softwares and competitors of Microsoft Dynamics AX
- Technology behind Microsoft Dynamics AX platform
- Framework on which Microsoft Dynamics AX platform is built
- Architecture of Microsoft Dynamics AX platform

On behalf of School of Computing & Information Technology we would like to thank our Honorable Chancellor **Dr. P. Shyama Raju**, Vice Chancellor Dr. K. Mallikharjuna Babu, Pro Vice Chancellor **Dr. M. Dhanamjaya**, Registrar **Dr. Beena**, Dean-placement, Training and Planning **Dr. N. Ramesh** for their continuous support.

We extend our special thanks to our beloved Director **Dr. Sunil Kumar S Manvi** for his continuous support, encouragement and motivation.

**Few Snaps of Technical talk**





44	Dhananjay D	R17CS108	CSE	7	B	r17cs108@cit.reva.edu.in
45	Ganesh Gaurav D	R17CS113	CSE	7	B	r17cs113@cit.reva.edu.in
46	Chandana M	R16CS542	CSE	7	C	R16CS542@cit.reva.edu.in
47	G.PRAVEEN KUMAR	R17CS124	CSE	7	C	r17cs124@cit.reva.edu.in
48	Sumanth	R17CS132	CSE	7	C	R17CS132@CIT.REVA.EDU.IN
49	G . Joshna chowdary	R17CS142	CSE	7	C	R17CS142@cit.reva.edu.in
50	Harsh mishra	R17CS148	CSE	7	C	r17cs148@cit.reva.edu.in
51	G Mohit	R17CS122	CSE	7	C	r17cs122@cit.reva.edu.in
52	SAI CHARAN	R17CS141	CSE	7	C	R17CS141@cit.reva.edu.in
53	G sai sandeep	R17CS126	CSE	7	C	R17cs126@cit.reva.edu.in
54	Gadde Venkata Sure	R17CS129	CSE	7	C	r17cs129@cit.reva.edu.in
55	G Niranjana Reddy	R17CS140	CSE	7	C	R17CS140@cit.reva.edu.in
56	Karthik	R17CS126	CSE	7	C	R17CS136@cit.reva.edu.in
57	G Tanmayee	R17CS127	CSE	7	C	R17CS127@cit.reva.edu.in
58	MANOJ MAHARRSHI	R17CS227	CSE	7	D	R17CS227@cit.reva.edu.in
59	Mahesh Bharti	R17CS218	CSE	7	D	R17CS218@cit.reva.edu.in
60	Merlyn.R	R17CS233	CSE	7	D	r17cs233@cit.reva.edu.in
61	Raunak Singh Chadr	R17CS332	CSE	7	F	r17cs332@cit.reva.edu.in
62	Priyanshu	R17CS312	CSE	7	F	R17CS312@cit.reva.edu.in
63	Mithun Surve	R17CS363	CSE	7	G	r17cs363@cit.reva.edu.in
64	Sharan Awati	R17CS378	CSE	7	G	R17CS378@cit.reva.edu.in
65	Sherin Sara Thomas	R17CS382	CSE	7	G	R17CS382@cit.reva.edu.in
66	Shalini G	R17CS375	CSE	7	G	R17cs375@cit.reva.edu.in
67	Shashidhar A B	R17CS380	CSE	7	G	R17cs380@cit.reva.edu.in
68	Umashankar E	R17EC372	ECE	7	D	r17ec372@ece.reva.edu.in
69	Meenuga Bhanu Kir	R17EE091	EEE	7	B	r17ee091@eee.reva.edu.in

Director's signature

School of Computer Science and Engineering  
REVA University  
Rukmini Knowledge Park, Kalitaganahalli  
Yelahanka, Bengaluru - 560 084

**SCHOOL OF COMPUTING AND INFORMATION TECHNOLOGY**  
**Technical Talk on "Text translation web applications with mail service "**  
**Attendance list**

Sl No	Name2	SRN (in caps)	School	SEM	SEC	REVA mail id
1	Mallayya Mathapati	R19CI046	CSIT	3	A	R19CI046@cit.reva.edu.in
2	D.Praveen	R19CI016	CSIT	3	A	R19CI016@cit.reva.edu.in
3	Bhanu priya B	R19CI009	CSIT	3	A	r19ci009@.cit.reva.edu.in
4	Poojashree C	R19CI080	CSIT	3	B	R19CI080cit@reva.edu.in
5	Pratham P	R19CI082	CSIT	3	B	R19CI082cit@reva.edu.in
6	Rakesh S.V	R19CI087	CSIT	3	B	R19CI087@CIT.REVA.EDU.IN
7	Rakesh S V	R19CI087	CSIT	3	B	R19CI087@cit.reva.edu.in
8	Abhijeet Jena	R18CS004	CSIT	5	A	R18CS004@cit.reva.edu.in
9	Marthala Bindu	R18CS521	CSIT	5	C	R18CS521@cit.reva.edu.in
10	Salony shah	R18CS529	CSIT	5	C	R18CS529@cit.reva.edu.in
11	Prashanth V	R18CS301	CSIT	5	E	R18CS301@cit.reva.edu.in
12	viresh sharanappa k	R19CS859	CSIT	5	I	r19cs859@cit.reva.edu.in
13	Amoolya M	R17CS026	CSIT	7	A	R17CS026@cit.reva.edu.in
14	Manasa C H	R17CS221	CSIT	7	D	R17CS221@cit.reva.edu.in
15	Aarya Nanndaann S	R19CS007	CSE	3	A	r19cs007@cit.reva.edu.in
16	Bhanu Prakash	R19CS056	CSE	3	A	r19cs056@cit.reva.edu.in
17	Abhilash.R	R19CS009	CSE	3	A	r19cs009@cit.reva.edu.in
18	Abhilash.R	R19CS009	CSE	3	A	r19cs009@cit.reva.edu.in
19	ANKITA SINGH	R18CS045	CSE	5	A	r18cs045@cit.reva.edu.in
20	A Mahasmrti	R18CS002	CSE	5	A	r18cs002@cit.reva.edu.in
21	Arpitha P K	R18CS062	CSE	5	A	arpi2205@gmail.com
22	Amogh Kuravatti	R18CS037	CSE	5	A	R18CS037@cit.reva.edu.in
23	Abhishek Dundagi	R18CS008	CSE	5	A	abhishekdundagi06@gmail.com
24	Abhishek Dundagi	R18CS008	CSE	5	A	r18cs008@cit.reva.edu.in
25	Chatakondou Venkat	R18CS092	CSE	5	B	r18cs092@cit.reva.edu.in
26	Mukul Rana	R18CS238	CSE	5	D	r18cs238@cit.reva.edu.in
27	mohammed namee	r18cs231	CSE	5	D	r18cs231@cit.reva.edu.in
28	PEEYUSH YADAV	R18CS283	CSE	5	E	r18cs283@cit.reva.edu.in
29	Prajwal M Patil	R18CS292	CSE	5	E	R18CS292@cit.reva.edu.in
30	P. Pramodhini	R18CS490	CSE	5	E	R18CS490@cit.reva.edu.in
31	Navitha A	R18CS249	CSE	5	E	R18CS249@CIT.REVA.EDU.IN
32	PERUMALLA VENKA	R18CS489	CSE	5	E	R18CS489@cit.reva.edu.in
33	Neelakanth S	R18CS254	CSE	5	E	R18CS254@cit.reva.edu.in
34	Sanjana S	R18CS371	CSE	5	G	r18cs371@cit.reva.edu.in
35	SAMUEL NITESH JOH	R19CS842	CSE	5	I	R19CS842@cit.reva.edu.in
36	Ashish NT	R17CS053	CSE	7	A	r17cs053@cit.reva.edu.in
37	Amrutha b p	R17CS027	CSE	7	A	R17CS027@cit.reva.edu.in
38	Anuradha H K	R17CS039	CSE	7	A	R17CS039@cit.reva.edu.in
39	ANUSHA.R	R17CS040	CSE	7	A	R17CS040@cit.reva.edu.in
40	Ambika YN	R17CS021	CSE	7	A	R17CS021@cit.reva.edu.in
41	ABHINAYA A	R17CS003	CSE	7	A	R17CS003@cit.reva.edu.in
42	ARPITHA K M	R17CS049	CSE	7	A	R17CS049@cit.reva.edu.in
43	B G Akshith Kumar P	R17CS066	CSE	7	B	r17cs066@cit.reva.edu.in

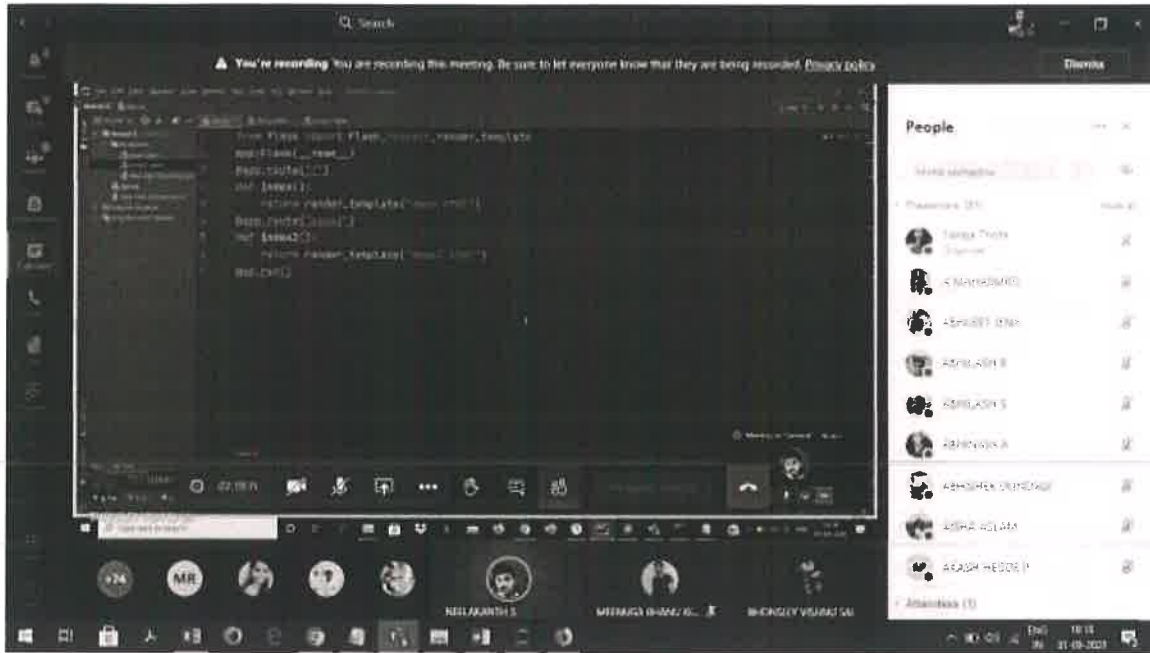

Image 4: Code demo

School of C & IT

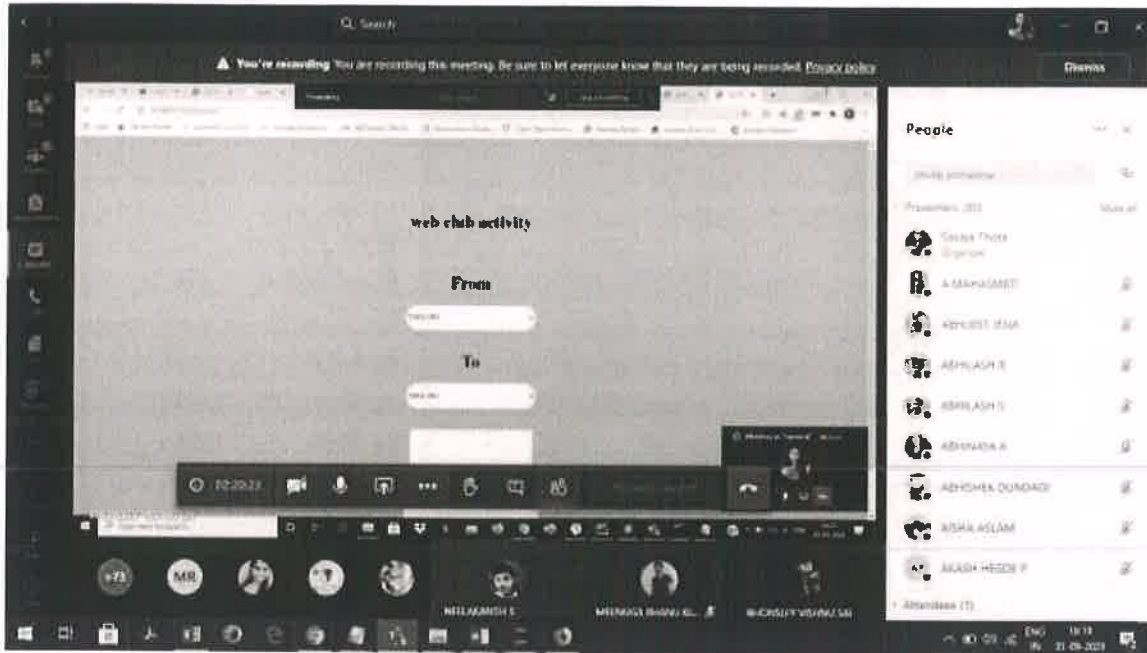

Image 2: Demo by Mr. Vishnu (Second page)

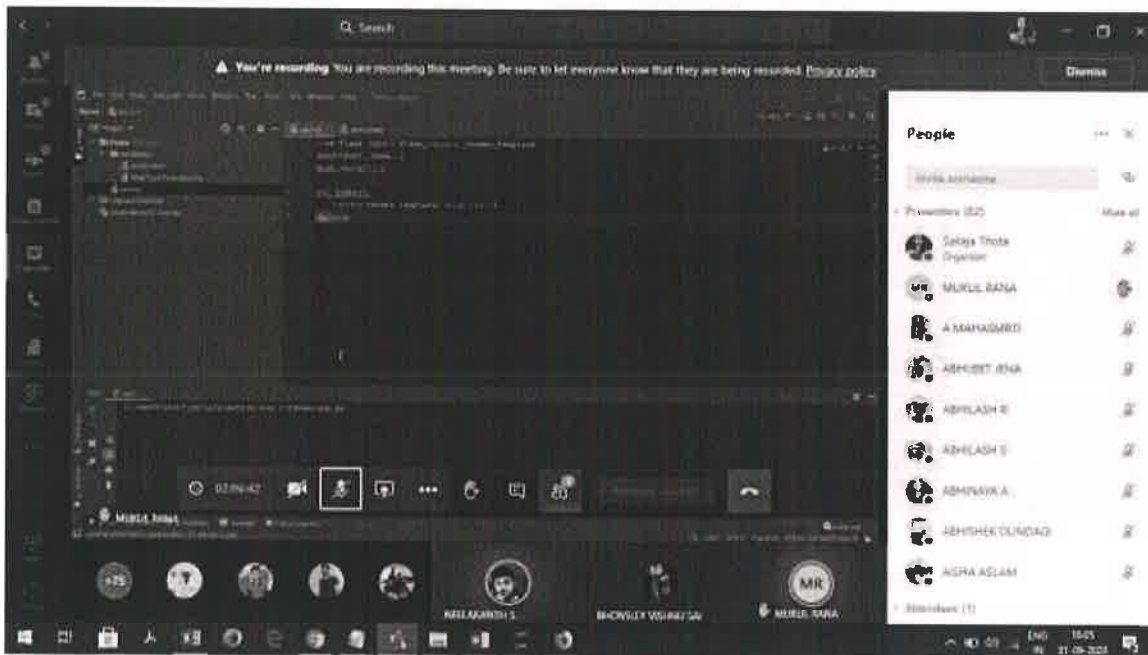
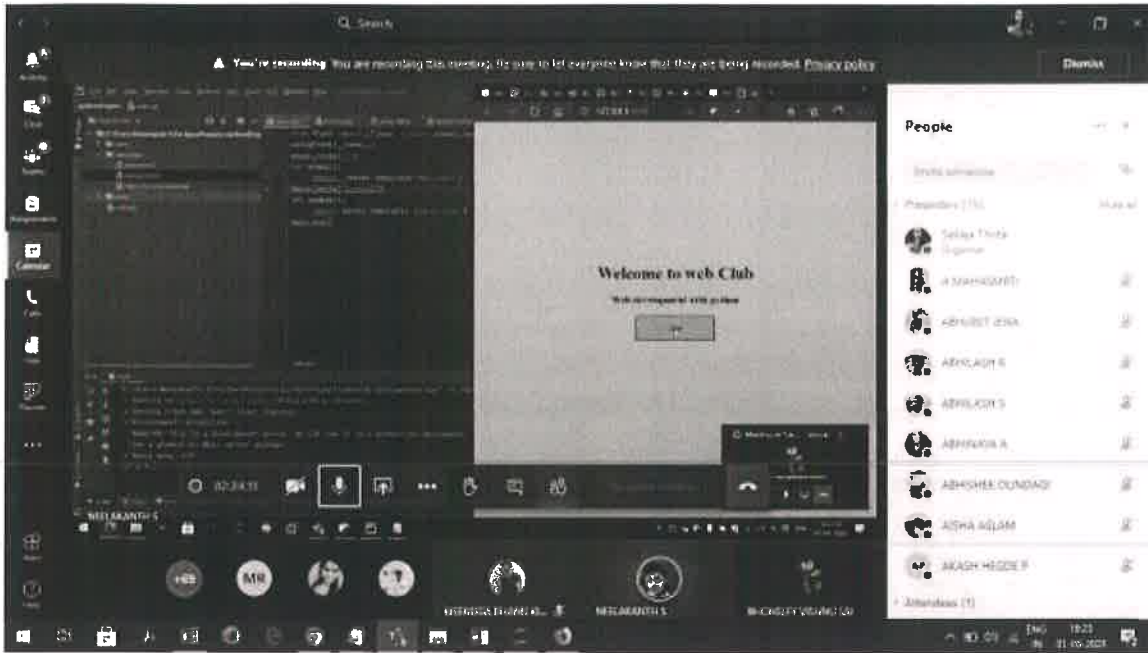
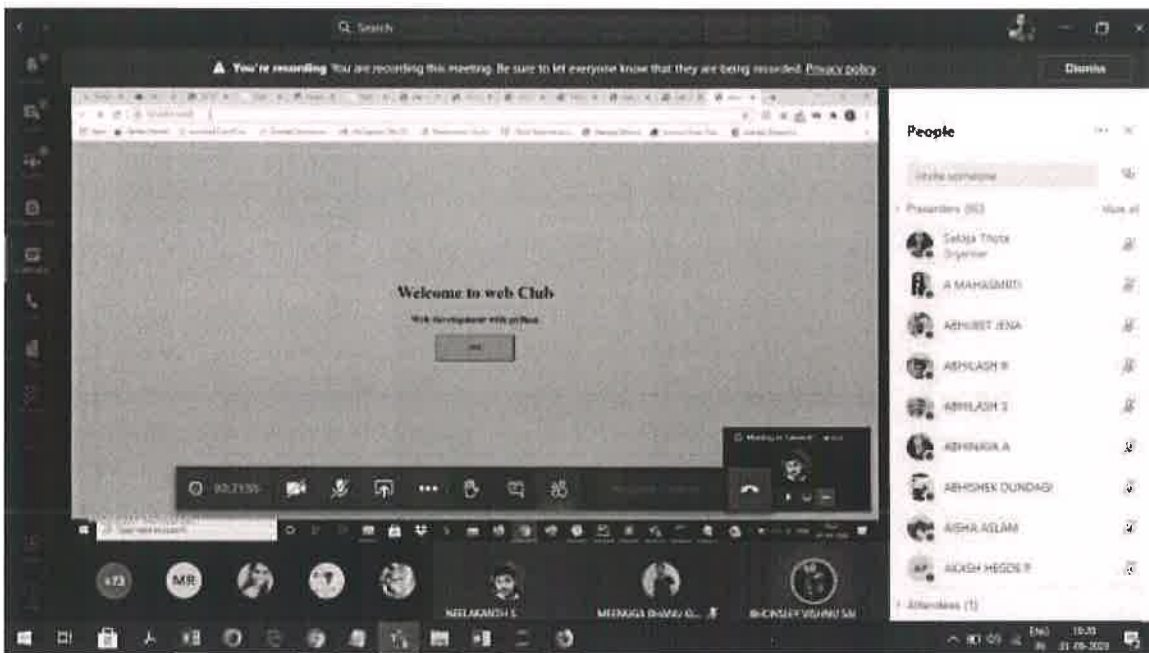

Image 3: Session ongoing





**Demo by Mr. Vishnu (home page)**



**Image 1: Mr. Neelakanth, participant shared his screen**

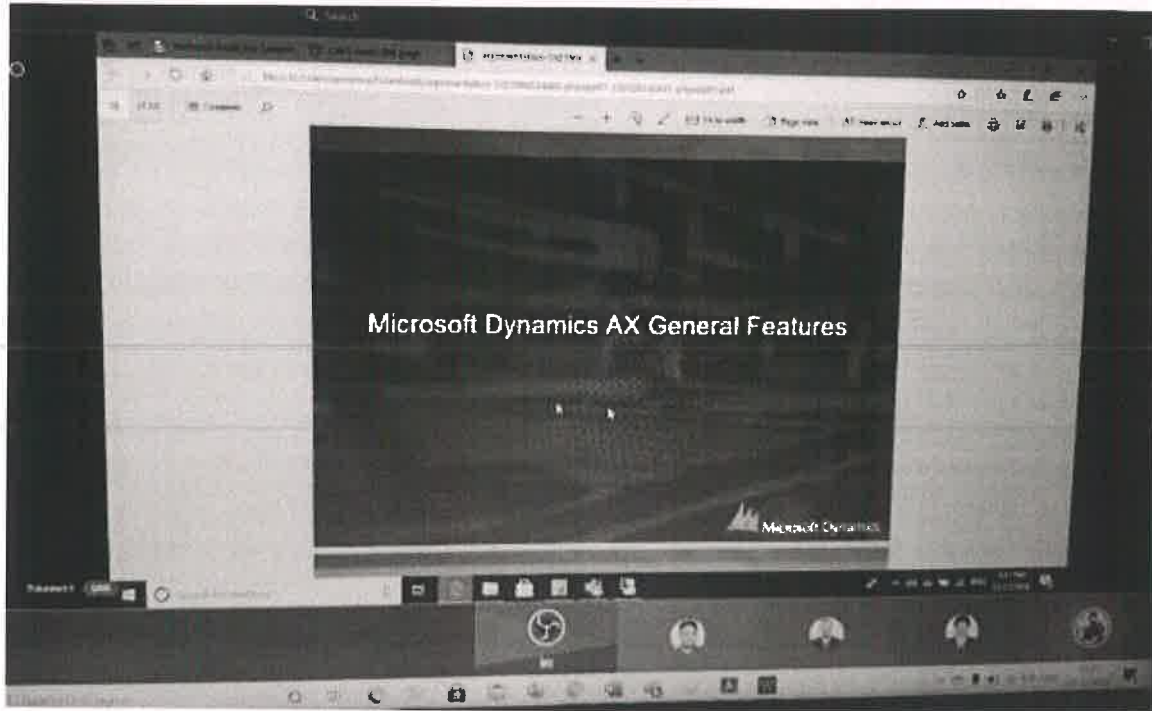

Snapshot1: Session started by resource person

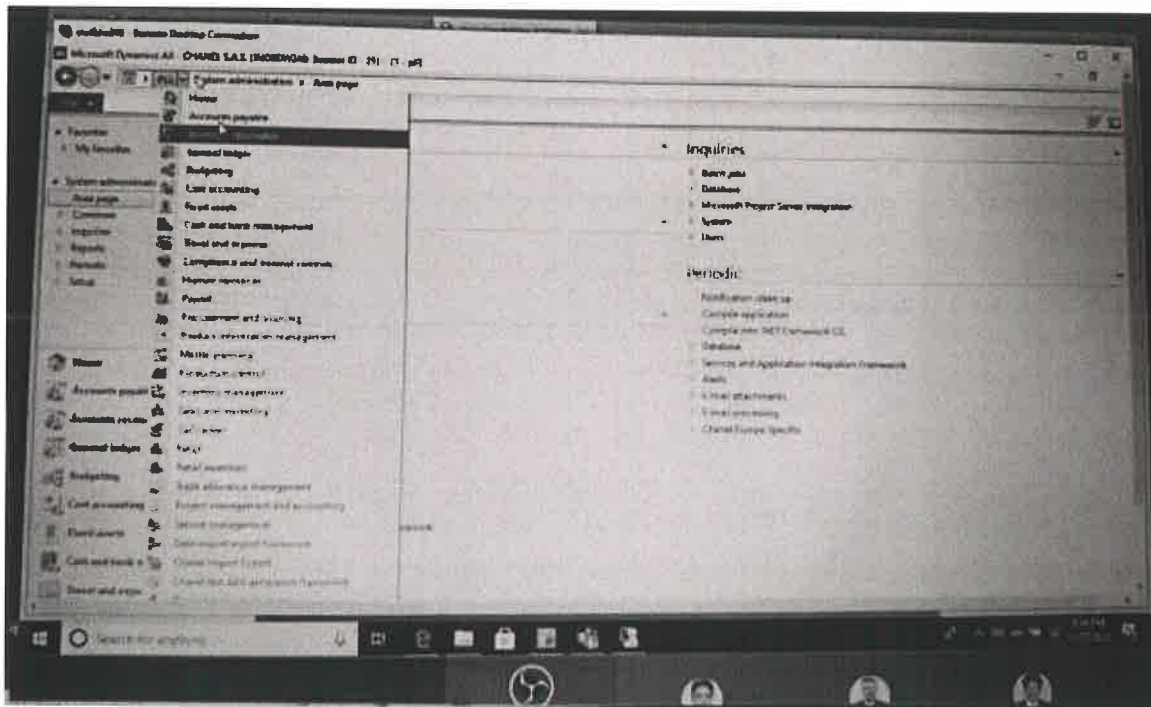

Snapshot2: Resource person is explaining

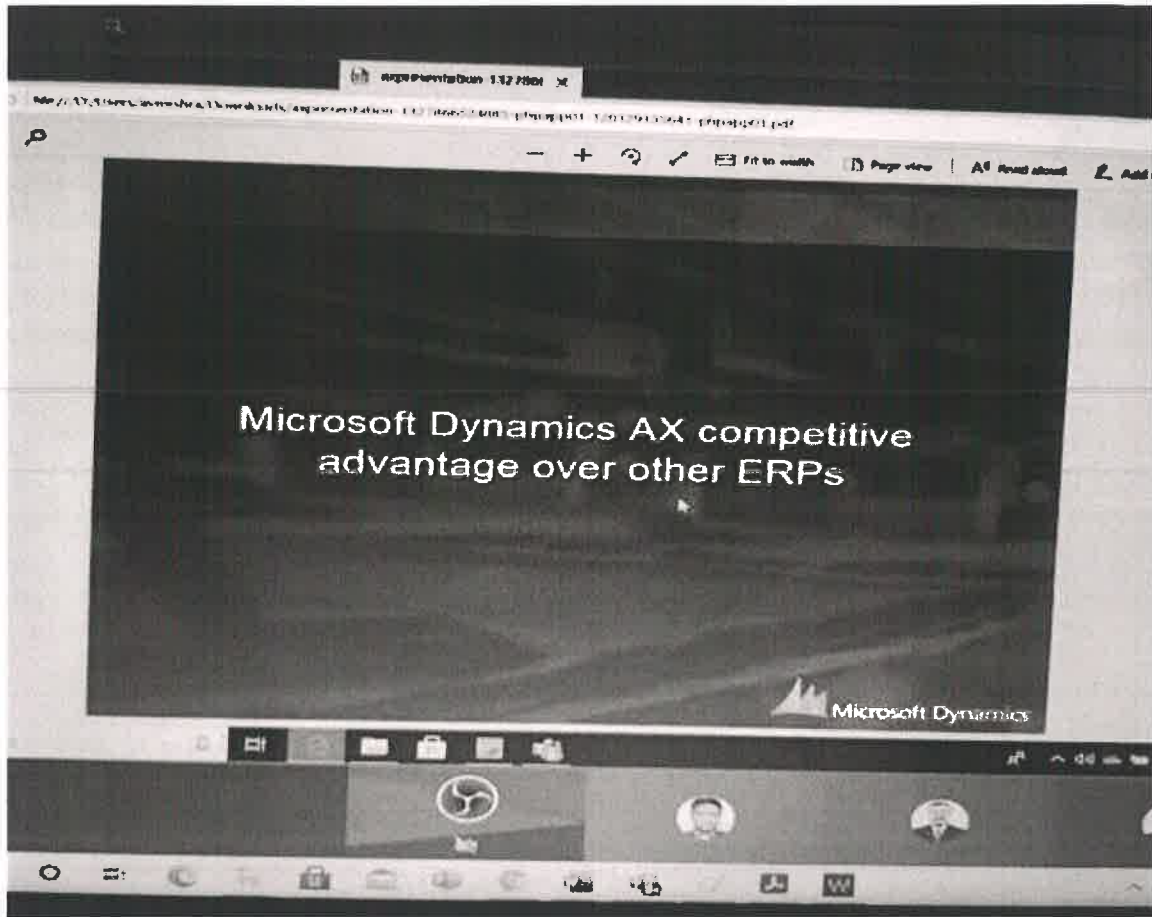

Snapshot3: Explaining the advantages of Microsoft Ax.

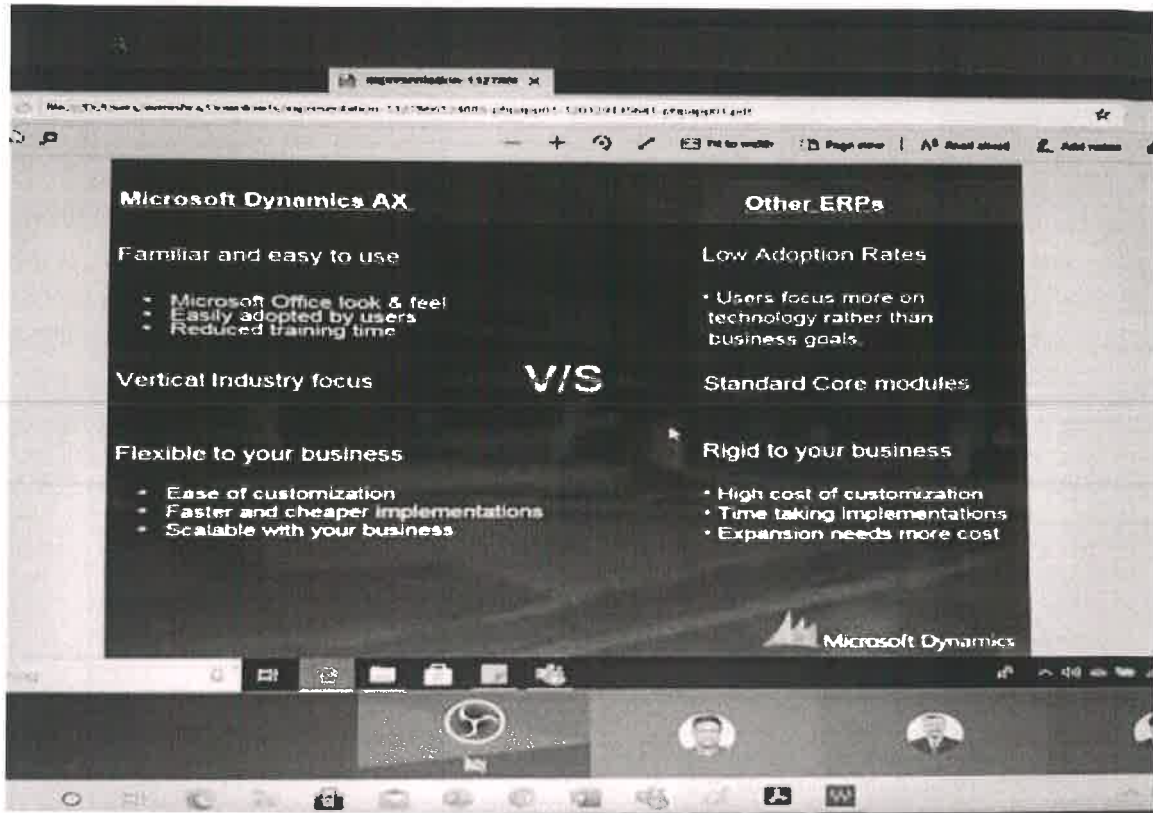

Snapshot4: Giving the difference between microsoft dynamic AX and other ERPs



**SCHOOL OF COMPUTING AND IT**
**Technical Talk on "Introduction to Microsoft Dynamics AX platform"**  
**Attendance list**

Sl. No	Participation Id	Name
1	R17CS479@cit.reva.edu.in	YATHISH C
2	R17CS438@cit.reva.edu.in	NALAM LAKSHMIRAVITEJA
3	R17CS516@cit.reva.edu.in	PRINCE SAJI
4	R16CS049@cit.reva.edu.in	ANKIT KUMAR
5	R17CS275@cit.reva.edu.in	NISHTHA TRIPATHI
6	R17CS530@cit.reva.edu.in	BALIREDDI JAHNAVI SAMYUKHA
7	R17CS080@cit.reva.edu.in	BINDU BHARGAVA REDDY CHINTAM
8	R17CS429@cit.reva.edu.in	SHIVARAJ
9	R19CS075@cit.reva.edu.in	VARSHITHA G
10	R17CS072@cit.reva.edu.in	VAMSHI
11	R18CS510@cit.reva.edu.in	VINAY N
12	R18CS278@cit.reva.edu.in	CHANDRU G
13	R18CS262@cit.reva.edu.in	CHANDRIKA N
14	R17CS295@cit.reva.edu.in	BATTU VENU
15	R18CS288@cit.reva.edu.in	DHANUSH M DHANUSH M
16	R18CS250@cit.reva.edu.in	PAVAN AJAY VARMA VARMA
17	R18CS259@cit.reva.edu.in	OMKAR R BHAGAT OMKAR R BHAGAT
18	R14CS123@cit.reva.edu.in	OMKAR R BHAGAT OMKAR R BHAGAT
19	R18CS291@cit.reva.edu.in	PRADEEP S
20	R18CS531@cit.reva.edu.in	POLURI VISHNUVARDHAN POLURI VISHNUVARDHAN
21	R18CS395@cit.reva.edu.in	POLURI VISHNUVARDHAN POLURI VISHNUVARDHAN
22	R18CS812@cit.reva.edu.in	NAYAK RAKSHITH GANAPATHI NAYAK RAKSHITH GANAPATHI
23	R19CS304@cit.reva.edu.in	NOEL JOHN CORREYA
24	R19CS318@cit.reva.edu.in	NAYAK RAKSHITH GANAPATHI NAYAK RAKSHITH GANAPATHI
25	R19CS300@cit.reva.edu.in	NEHAL SINGH
26	R19CS807@cit.reva.edu.in	PAVAN AJAY VARMA VARMA
27	Amet-Vikram.Mishra@chanel.	PRADEEP R S PRADEEP R S
28	R19CI087@cit.reva.edu.in	SHASHANK G G
29	R19CI090@cit.reva.edu.in	SHILPA SHILPA
30	R19CS177@cit.reva.edu.in	SHILPA SHILPA
31	R19CS152@cit.reva.edu.in	KAVYA R
32	R19CS167@cit.reva.edu.in	SHILPA SHILPA
33	R19CS133@cit.reva.edu.in	SHIVAM SHARMA
34	R19CS149@cit.reva.edu.in	SRILAKSHMI ALLAM
35	R19CS180@cit.reva.edu.in	SHAIK RUHUL AMEEN
36	R19CS173@cit.reva.edu.in	AJAYKUMAR B S AJAYKUMAR B S
37	R19CS132@cit.reva.edu.in	SHAIK RUHUL AMEEN
38	R19CS144@cit.reva.edu.in	MD RUHUL AMEEN
39	R19CS175@cit.reva.edu.in	PRINCE SAJI
40	R19CS163@cit.reva.edu.in	Amet Vikram MISHRA
41	R19CS157@cit.reva.edu.in	RAKESH S V
42	R17CS356@cit.reva.edu.in	RISHITH C
43	thirumagal.e@reva.edu.in	THIRUMAGAL
44	R19CS161@cit.reva.edu.in	BALIREDDI JAHNAVI SAMYUKHA
45	R19CS154@cit.reva.edu.in	MAHENDRAKAR VENKATA PAVAN RAO
46	R19CS191@cit.reva.edu.in	KATTA KAMALA REETHIKA
47	R19CS172@cit.reva.edu.in	KUSHALA KUMARI S
48	R17CS440@cit.reva.edu.in	KUSUM

Sl. No	Participation Id	Name
49	R17CS328@cit.reva.edu.in	SHASHIKALA
50	R17CS484@cit.reva.edu.in	HRUDAY H
51	R19CS179@cit.reva.edu.in	KARUNAMAYI IJJADA
52	R17CS517@cit.reva.edu.in	MANASA R
53	R17CS502@cit.reva.edu.in	HRUDAY H
54	R17CS452@cit.reva.edu.in	M RAGAVI
55	R19CS187@cit.reva.edu.in	HRITESH J
56	R17CS361@cit.reva.edu.in	KALLA ABHINAY REDDY
57	R19CS137@cit.reva.edu.in	ABHISHEK
58	R17CS351@cit.reva.edu.in	MABBU DIVYA
59	R17CS338@cit.reva.edu.in	KRITHIK GOPINATH
60	R17CS473@cit.reva.edu.in	KALLA ABHINAY REDDY
61	R17CS443@cit.reva.edu.in	KEERTHI N
62	R19CS184@cit.reva.edu.in	SANDEEP P
63	R17CS347@cit.reva.edu.in	KRITHIK GOPINATH
64	R17CS343@cit.reva.edu.in	Thirumagal E
65	R17CS305@cit.reva.edu.in	KALLA ABHINAY REDDY
66	R17CS472@cit.reva.edu.in	KOTHA SUMANTH
67	R19CS139@cit.reva.edu.in	KATTA KAMALA REETHIKA
68	R17CS346@cit.reva.edu.in	GEETHA
69	R19CS143@cit.reva.edu.in	HRUDAY H
70	R19CS045@cit.reva.edu.in	KALLA ABHINAY REDDY
71	R19CS471@cit.reva.edu.in	KAVYA K
72	R19CS142@cit.reva.edu.in	KUSHALA KUMARI S
73	R17CS524@cit.reva.edu.in	SYED SAUBAN
74	R17CS499@cit.reva.edu.in	KAVYA K
75	R19CS155@cit.reva.edu.in	HRUDAY H
76	R17CS323@cit.reva.edu.in	M.J JYOTHISH
77	R19CS023@cit.reva.edu.in	NISHCHAY M
78	R19CS138@cit.reva.edu.in	KUSHALA KUMARI S
79	R18CS318@cit.reva.edu.in	RAMIREDDY DEVENDRANATHREDDY OBULAREDDY
80	R18CS823@cit.reva.edu.in	YOGITHA S
81	R19CS160@cit.reva.edu.in	MANAS PATIL
82	R19CS189@cit.reva.edu.in	KALLA ABHINAY REDDY
83	R18CS342@cit.reva.edu.in	KAVYA R
84	R18CS314@cit.reva.edu.in	MANAS PATIL

  
 Director Signature
   
 27/11/20



**School: ECE**

**Title: Intra Department Sports Activities**

**Organized by: ECE Challengers Sports Club, School of ECE**

**Venue: REVA University**

**Date: 13<sup>th</sup> March to 18<sup>th</sup> March 2021**

**Description of Event:** The School of ECE sports club, REVA University had organized “Intra department sports activities” for the benefit of students from 13<sup>th</sup> March 2021 to 18<sup>th</sup> March 2021. Around 250+ students were participated in this event.

We would like to thank our beloved Chancellor, Dr. P. Shyama Raju for providing all facilities and support to conduct this program. We also thank Vice Chancellor Dr. M. Dhanamjaya, Registrar I/C Dr. N. Ramesh, Director of school of ECE Dr. R C. Biradar, Assist. Director Dr Sudharshanand faculty school of ECE for their motivation and support in making this event a grand success.

**Event details:**

S.no	Event name	Date	Winners	Runners
1.	Cricket	13 <sup>th</sup> to 15 <sup>th</sup> March 2021	Tharak and Team	Balaji and Team
2.	Volleyball	16 <sup>th</sup> to 17 March 2021	SreeCharan and Team	Sohith and Team
3.	Basketball	16 <sup>th</sup> March 2021	Vinay Team	Ayush Team
4.	Chess	17 <sup>th</sup> March 2021	Harish	Harshith
5.	Table Tennis(M)	17 <sup>th</sup> March 2021	Anirudh	Gagan
6.	Table Tennis (W)	17 <sup>th</sup> March 2021	Prachi	Anusha
7.	Throwball	17 <sup>th</sup> March 2021	Vinodh and Team	Aravindh
8.	Throwball(W)	17 <sup>th</sup> March 2021	Vidya and Team	Yogalakshmi and Team
9.	Football	17 <sup>th</sup> March 2021	Raviprakash and Team	Gabriel and Team
10.	Badminton(M)	17 <sup>th</sup> March 2021	Hemanth and team	Durga and Team
11.	Badminton(W)	18 <sup>th</sup> March 2021	Madeedha and team	Harshitha and Team
12.	Kabaddi	18 <sup>th</sup> March 2021	Chethan and Team	Rajesh and Team

Activity Co-ordinator: Prof. K Durga Prasad

  
 Director  
 School of Electronics &  
 Communication Engineering  
 REVA University, Rukmini Knowledge Park  
 Kattigenahalli, Yelahanka, Bengaluru - 560 064



**REVA**  
**UNIVERSITY**  
Bengaluru, India

## School of Electronics and Communication Engineering

### Circuit Debugging Contest

**Club:** ISF/IETE Club

**Coordinators:** Prof. Vidyasagar K. N. and Prof. Amrut Anilrao Purohit

**Venue:** Room No. 219,C V Raman Block

**Date:** 28/01/2021

**Time:** 2.30pm to 04.30pm

**Participants:** B. Tech (ECE & ECM) Students (Around 28 participants).

The ISF CLUB (IETE Students Forum) from School of ECE has organized a Circuit Debugging Contest for the School of ECE students on account of IETE Student's day which falls on 1<sup>st</sup> February 2021. The Contest was conducted with a Circuit given and students were asked to obtain the circuit parameters. Around 28 participants from first year participated to demonstrate their Circuit Debugging skills. This type of contests will help students to know their competency level. Further they can improve their skills which in-turn helps them in cracking their core company placement interviews.

On behalf of School of Electronics and Communication Engineering and ISF Club we would like to thank our Honorable Chancellor **Dr. P. Shyama Raju**, Pro- Vice Chancellor **Dr. Dr. M. Dhanamjaya**, Registrar **Dr. Beena G**, Dean-placement, Training and Planning **Dr. N. Ramesh** for their continuous support. We extend our special thanks to our beloved Director **Dr. R. C. Biradar** and Deputy Director **Dr. K. M. Sudarshan** for their continuous support, encouragement and motivation.

#### Outcome

On completion of this contest the student will be able to:

1. Demonstrate the application of KCL and KVL in DC circuit.

#### Mapping of Course Outcomes with Program Outcomes

POs/ COs	PO1	PO2	PO3	PO4	PO5	PO6	PO7	PO8	PO9	PO 10	PO 11	PO 12
CO1			3	3	3				3	3		





 **REVA**  
UNIVERSITY  
Bengaluru, India



**IETE STUDENTS  
DAY - 2021**

**CIRCUIT DEBUGGING CONTEST**



  
**Director**  
School of Electronics &  
Communication Engineering  
REVA University, Rukmini Knowledge Park  
Kattigenahalli, Yelahanka, Bengaluru - 560 064



**School of Electronics and Communication Engineering**

**“Dots & Pixels” CLUB associated with TEAM 4 presents**

**A webinar on “Digital Video Coding for Next Generation Multimedia”**

School of Electronics and Communication Engineering, “Dots & Pixels” Club has successfully organized a webinar on “Digital Video Coding for Next Generation Multimedia” on 02 November, 2020. Participants attended the webinar were final year students from the School of ECE and others in the presence of faculty coordinator Prof. Anitha Kumari.R.D and Professors of ECE

The resource person was **Mrs. Shreyanka Subbarayappa** is an Assistant Professor in the Department of Electronics and Communication Engineering at Ramaiah University of Applied Sciences, Bangalore. Having more than 59 participants including students and ECE Faculties of REVA University actively attended the session.

The event began at 6:00PM where all the participants were asked to login portal prior to the event and being conducted on MS Teams. The duration of the event was one hour and the participants were highly enthusiastic about this event. The event ended with discussion of doubts with the students and positive feedback from professors and students.

The key highlights were:

1. A brief introduction to Compression
2. Concept of image and video Compression.
3. Methods of Image and Video compression.
4. Introduced various opensource software of an video codecs..

## School of Arts & Humanities

**Event: Theme-Based Poetry Recitation**

**Date: 24 September 2020**

Poetry Club, School of Arts and Humanities of REVA University conducted Theme-Based Poetry Recitation competition on 24<sup>th</sup> September 2020 through online conferencing platform, Microsoft Teams. There were around 82 participants. Students from various programmes participated in the event with great zeal.

It was an individual event. Every participant had to pick a poem related to the theme **-English:** Memory lane/Love, **Kannada:** ಪ್ರೀತಿ/ ಹಳೆಯ ನೆನಪು, **Hindi:** पुरानी यादें /प्रेम and recite it for 90 seconds in English, Kannada or Hindi. The criteria for judging the poetry recitation included relevance to the theme, presentation or harmony of words, clarity of imagery and language. The event made the students realise the importance of words, different expressions used in language. Faculty Coordinators shared their thoughts on poetry recitation and also informed students that poetry is a great tool to express individual's intense emotions.

The faculty coordinators were Prof. Ashitha K, Dr. Maya and Prof. Lingappa and the judges for the event were Dr.Khusboo Gokani, Dr.Sreenivasa Murthy and Dr.Prasanna D J.

The winners of English poetry recitation –

- First Place- Alibhia, I Sem. B.com (honours)
- Second Place-Mehak Khan, I Sem.BA Tourism.

- Third Place- Shivani T, III Sem BA PEJ and Pavithra Bhat, III Sem. BA JEP

The winners of Hindi Poetry recitation-

- First Place- Pranshu, I BBA
- Second Place-Anu Singh, III Sem BA JEP and Anchal, III Sem BA JEP
- Third Place- Ravindra singh, I BCom

The winners of Kannada poetry recitation –

- First Place- Kanya, I BCom
- Second Place-Hemanth R, I BCom
- Third Place- G M Radha, III sem BSc

The students expressed their happiness for providing them a platform to render beautiful poems.

**Link:** <https://web.microsoftstream.com/video/5533a888-1406-4dbd-8c0f-c22422caa793>

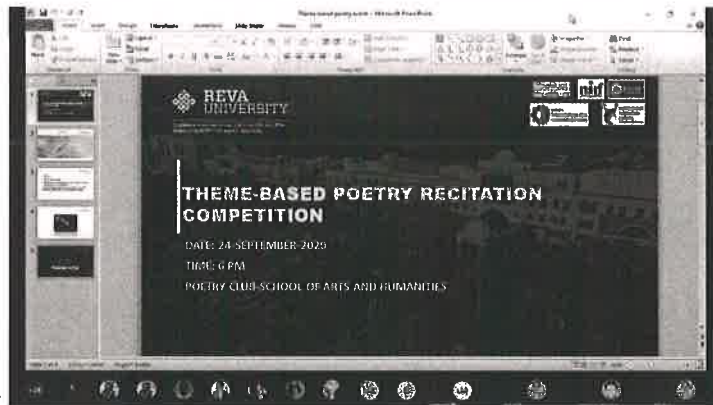

Object

link -

  
Director  
School of Arts, Humanities  
& Social Sciences  
REVA University, Rukmini Knowledge  
Kattigenahalli, Yelahanka, Bangalore-560075



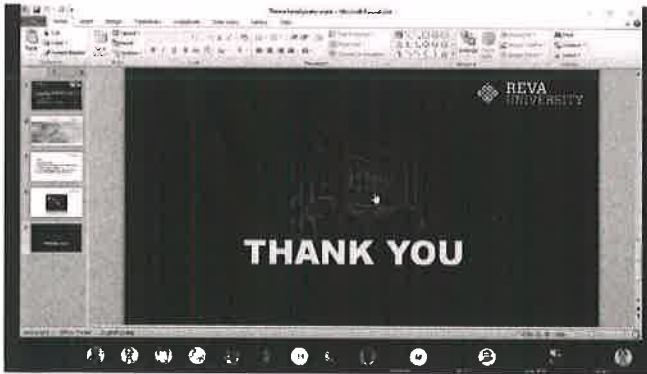
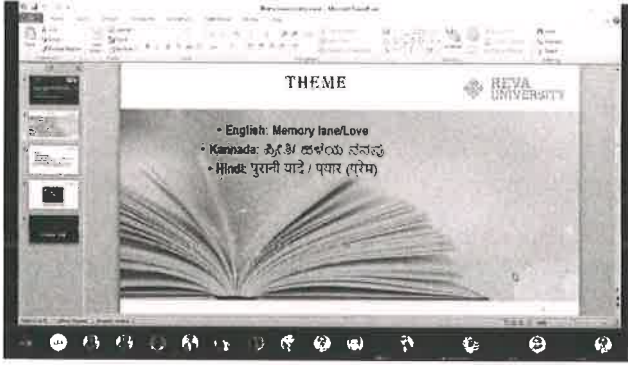



## School of Arts, Humanities and Social Sciences

- 34
- List of Clubs.  
- School wise -
  - Logo inlact
  - Annual report
  - List of activities
  - Endences

### Event: Book Club Activity

Date: 31 March 2021

The School of Arts, Humanities and Social Sciences of REVA University conducted a Book Club Activity - Book Review and Discussion (Book Club Activity) on 31st March, 2021. There were around 28 participants from different Schools. The activity was based on book review. The participants had to speak about a book of their choice, which had great impact in their lives. They had to speak for about three minutes and convince the audience to read them. The participants showed their prowess in sharing their cognitive sensibilities related to different genres of books like psychological thriller, philosophical, self-help, romance etc. Four winners were declared. Prof. Sompurba Basu was the coordinator and judge of the event.

## School of Arts, Humanities and Social Sciences *Book Review and Discussion*

### BOOK CLUB

#### CIRCULAR

Date: 31 March, 2021

Time: 3.30 p.m.

Venue: 8<sup>th</sup> Floor, Room no. 820, Swami Vivekananda Block

#### Note:

- It is an individual event, to be conducted in English.
- Every participant must write a review of a book that he/she has read and that has impacted his/her life, prior to the activity.



**REVA**  
**UNIVERSITY**

Bengaluru, India

- On the day of the event, he/she should present the book review within 3-4 mins and convince others to read the book.
- Criteria for judgement – Content, Fluency and Expression.
- Registration closes on 30 March, 2021 at 4.30 p.m.

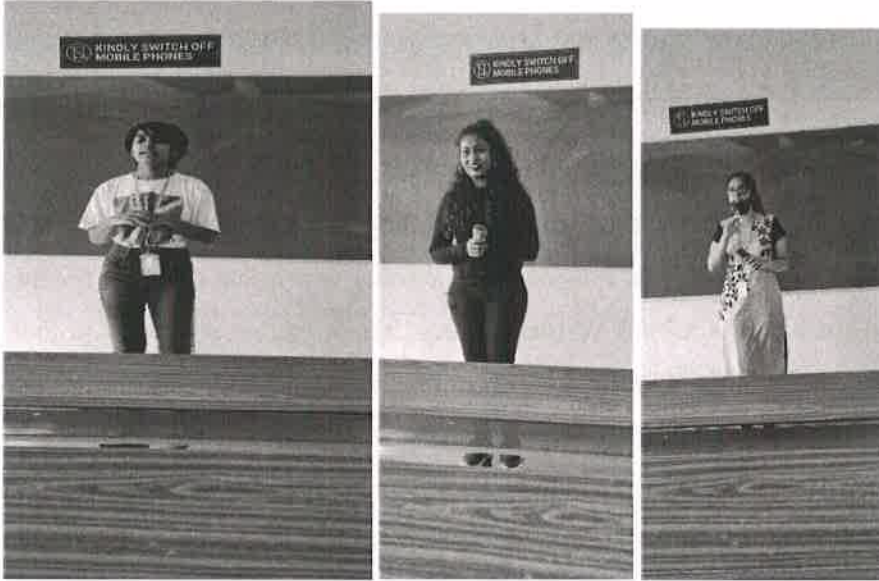

*Dulle*  
Director

School of Arts, Humanities  
& Social Sciences

REVA University, Rukmini Knowledge Park,  
Gogenahalli, Yelahanka, Bangalore-56



**REVA**  
**UNIVERSITY**  
BENGALURU • INDIA

**School of Electronics and Communication Engineering**

**CODER'S CLUB associated with TEAM 2 presents**

**A workshop on “Introduction to Android application development”**

School of Electronics and Communication Engineering, Coder's Club has successfully organized a workshop on “Introduction to Android application development” on 19th of September, 2020. Delegates attending the webinar were students from the School of ECE, School of C&IT and others in the presence of faculty coordinator Prof. J Chaitra Nayak and Professors of C&IT and ECE.

The workshop was conducted by resource persons of the coder's club **Mr. Niran and Mr. Shreevallabha**. Having more than 59 participants including students and Faculties of Reva University C&IT and ECE actively attended the session.

The event began at 11:00AM where all the participants were asked to login and register onto the given portal prior to the event and being conducted on MS Teams. The duration of the event was one hour and thirty minutes. The participants were highly enthusiastic about this event. Prerequisites of the workshop were given to participants 2 days prior. Students successfully built an “Dice rolling” application. The event ended with discussion of doubts with the students and positive feedback from professors and students.

The key highlights of the program were:

1. A brief introduction to Android.
2. Concept of Android Architecture.
3. The methods of developing applications.
4. Carrier as an android app development.
5. Introduce an android app studio.





**School:** Electronics and Communication Engineering

**Title:** Coder's club presents Python Quiz Competition

**Date:** 10th October 2020

**Location / Mode of Conduction:** Online using MS-Teams

**Description:** The School of Electronics of Communication Engineering Coder's Club successfully conducted its event on 10 October 2020. Participants attending the Python Quiz were students from the 5th sem of School of ECE in the presence of faculty coordinator Prof. J ChaitraNayak.

The event was a **Python Quiz Competition** with 40 students participating. The event began at 12:30PM where all the participants were asked to login and register onto the given portal prior to the event and being conducted on MS Teams and quiz was conducted on Microsoft Forms. The duration of the event was for thirty minutes. The participants were highly enthusiastic about this event.

A sincere congratulations on such a successful event. The Quiz was very well organized, both logistically and in terms of its contents. An extended thank you to our faculty coordinator Prof. J ChaitraNayak and all the members of Coder's Club without whom the event wouldn't have been a great success.

We would like to thank our beloved Chancellor, Dr. P. ShyamaRaju sir for providing all facilities and support to conduct this program. Respected Vice Chancellor sir, Registrar DrM.Dhanamjaya sir, for their motivation, help and support to conduct this webinar. We also thank our Director, School of ECE, Dr. R C. Biradar sir, and Assistant Director Dr. K M Sudarshan sir for their constant support and always motivating us to organize such events in School of ECE.

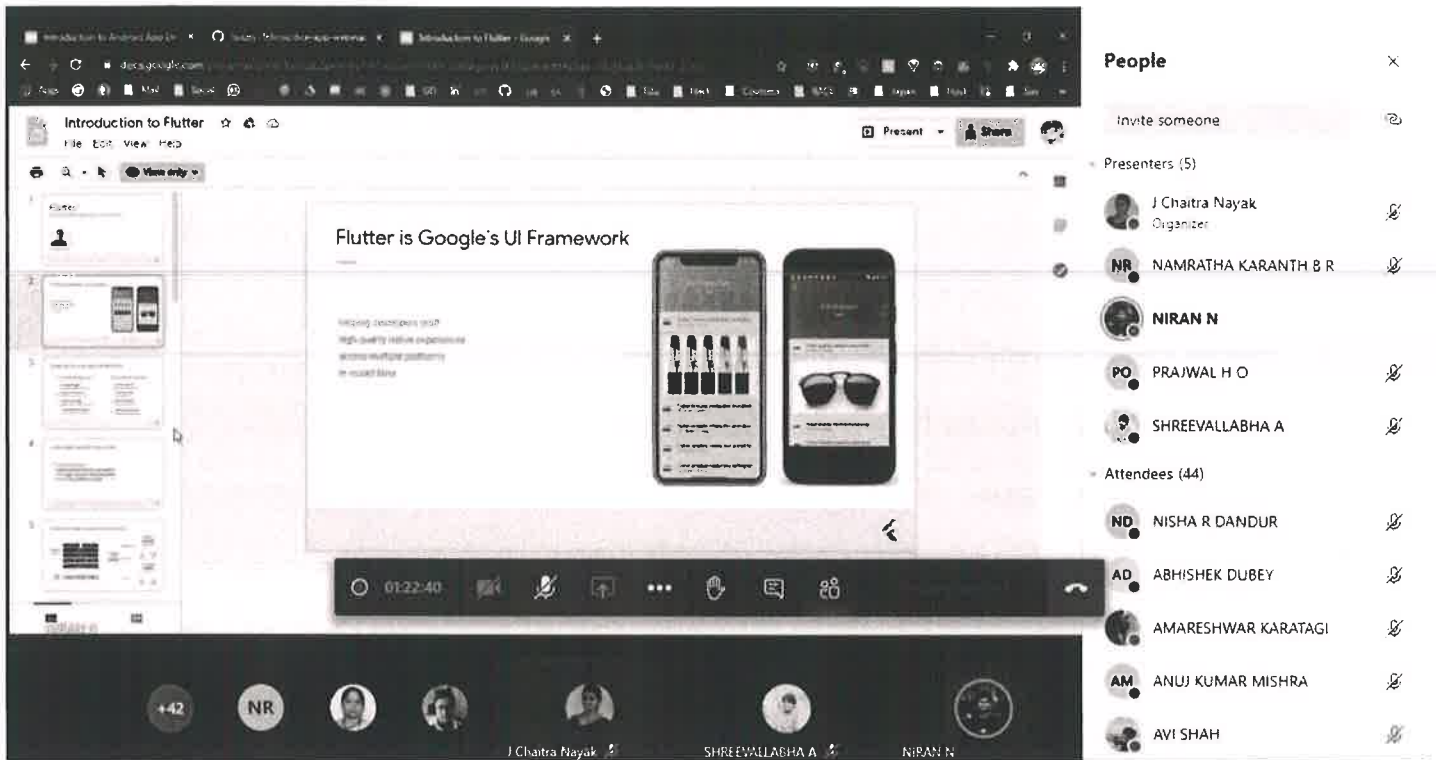

We would like to thank our beloved Chancellor, Dr. P. ShyamaRaju sir for providing all facilities and support to conduct this program. Respected Vice Chancellor sir, Registrar Dr.M.Dhanamjaya sir, for their motivation, help and support to conduct this webinar. We also thank our Director, School of ECE, Dr. R C. Biradar sir, and Assistant Director Dr. K M Sudarshan sir for their constant support and always motivating us to organize such events in School of ECE. An extended thank you to our faculty coordinator **Prof. J Chaitra Nayak** and our resource persons **Niran** and **Shreevallabha** without whom the event wouldn't have been a great success.

The webinar recorded link:

<https://web.microsoftstream.com/video/cb02a70c-a678-49b4-8b57-204d5341f2d6>



The screenshot shows a Zoom meeting in progress. The main window displays the Android Studio interface with a virtual device running an application. The application screen shows a white background with a black square and a small black dot inside it. The Android Studio interface includes a project tree on the left, a central editor, and a bottom toolbar. The Zoom meeting interface is visible at the bottom, showing a chat window with the message "install successfully finished in 14.406 ms." and a bottom toolbar with icons for mute, video, chat, and other controls. On the right side, a "People" list is open, showing the following participants:

- Invite someone
- Presenters (5)
  - J Chaitra Nayak (Organizer)
  - NR NAMRATHA KARANTH S R
  - NIRAN N
  - PO PRAJWAL H O
  - SHREEVALLABHA A
- Attendees (33)
  - ND NISHA R DANDUR
  - AD ABHISHEK DUBEY
  - AMARESHWAR KARATAGI
  - AJ AYUSH JHA
  - AR AYUSH RAI

At the bottom of the Zoom window, there are several circular icons representing participants: a "+31" icon, "BN", "NR", and three profile pictures. Below the icons, the names "J Chaitra Nayak", "NIRAN N", and "SHREEVALLABHA A" are visible.

# Introduction to Android

- **Android** is a complete set of software for mobile devices such as tablet computers, notebooks, smartphones, electronic book readers, set-top boxes etc.
- It contains a **linux-based Operating System, middleware and key mobile applications.**
- The goal of android project is to create a successful real-world product that improves the mobile experience for end users.

32:29

NIRAN N

+42

DS

PALAGIRI ROSHAN

SANJA ZAIN R

AVI SHAH

NAMRATHA KARANT...

J Chattra Nayar

NIRAN N





**REVA**  
**UNIVERSITY**

Bengaluru, India



**REVA**  
**UNIVERSITY**

Bengaluru, India

Established as per the section 2(f) of the UGC Act, 1956  
Approved by AICTE, COA and BCI, New Delhi

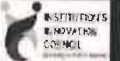

MHRD'S  
INNOVATION CELL



School of Electronics and Communication Engineering  
in association with Coders Club

Organises Webinar on

# Introduction to Android Application Development

Speakers



**Shreevallabha A**

Student, School of ECE  
REVA University



**Niran N**

Student, School of ECE  
REVA University

Date : 19<sup>th</sup> September, 2020

Time : 11:00 A. M.

[www.reva.edu.in](http://www.reva.edu.in)

## Kotlin? What's that??



Your microphone is muted.

35:29 [Microphone icon] [Hand icon] [Chat icon] [More icon]

NIRAN N

+44

DS



PALAGIRI ROSHAN

SR

SANIA ZAIN R



AVI SHAH

NR

NAMRATHA KARANT...



J Chaitra Nayak



NIRAN N

6. Build a small android app [ Dice game].

The Pos mapped are: PO2, PO3, PO4, PO5, PO7, PO8, PO9, PO10

Gallery

---



Director  
School of Electronics &  
Communication Engineering  
REVA University, Rukmini Knowledge Park  
Kattigenahalli, Yelahanka, Bengaluru - 560 064



**REVA**  
**UNIVERSITY**  
B E N G A L U R U • I N D I A

## **School of Electronics and Communication Engineering**

### **Coder's Club Presents Tech Talk on Arduino**

The School of Electronics and Communication Engineering Coder's Club successfully conducted its event on the 18th of March, 2021 in Aryabhatta seminar hall. Delegates attending the program were students from the School of ECE and ECM in the presence of Director and Assistant Director, School of ECE and faculty coordinator Prof. Chaitra Nayak J.

The tech talk was conducted by resource person Mr. Adarsh Bhatt student from final year, School of ECE. Having around 50 and above students of Reva University ECE and ECM actively attended the session.

The event began at 9:45AM where all the students were asked to assemble in the Aryabhata seminar hall. The duration of the event was one hour and thirty minutes. Students were highly enthusiastic about this event. The Event began with Miss Nethra giving the welcome speech and Vice President Niran briefing about the coder's club and Director guiding the students. The event came to an end with discussion of doubts with the students and resource person. A sincere congratulations on such a successful event. The tech talk session was very well organized, both logistically and in terms of its content.

We would like to thank our beloved Chancellor, Vice Chancellor for providing all the facilities and support to conduct this program. We also thank our Director, School of ECE, Dr. R.C. Biradar and Assistant Director Dr.Sudarshan K M for their constant support and guidance.

The Pos mapped are: PO3, PO4, PO5, PO8, PO9

**Photos:**



REVA  
UNIVERSITY

Bengaluru, India







**REVA**  
UNIVERSITY

Bengaluru, India

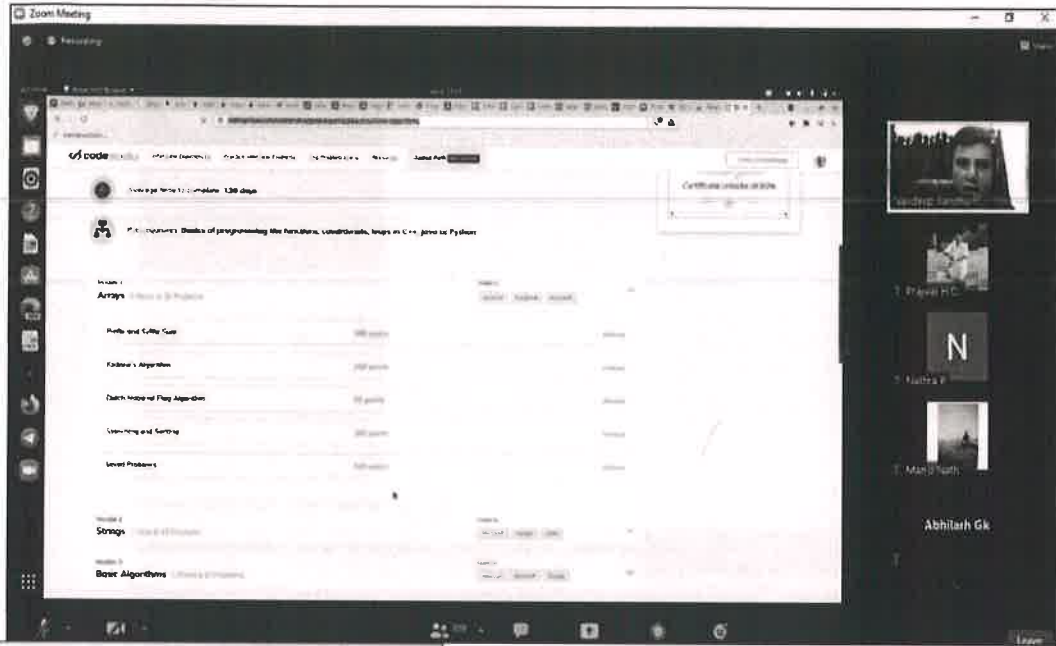

SF	Shehariyar F S		
	shreevallabha5hâr"ma		
SS			
	Shushrutha K		
SA	Shwetha A Sinchana		
S	Shekar Sindhuja CP		
	sahas vijay		
	SumaGoWA		
UP			

**Director**  
**School of Electronics &**  
**Communication Engineering**  
**REVA University, Rukmini Knowledge Park**  
**Kattigenahalli, Yelahanka, Bengaluru - 560 064**



**495. Max Consecutive Ones**

Given a binary array `nums`, return the maximum number of consecutive 1's in the array.

**Example 1:**

**Input:** `nums = [1,1,0,1,1,1]`  
**Output:** `3`  
**Explanation:** The first two bits of the last three digits are consecutive 1s. The maximum number of consecutive 1s is 3.

**Example 2:**

**Input:** `nums = [0,1,1,0,0,1,1,0,0]`  
**Output:** `2`

**Constraints:**

- `1 <= nums.length <= 105`
- `nums[i]` is either 0 or 1.

```
class Solution {
public:
    int findMaxConsecutiveOnes(vector<int>& nums) {
        int n = nums.size();
        int maxOnes = 0;
        int currentOnes = 0;
        for (int i = 0; i < n; i++) {
            if (nums[i] == 1) {
                currentOnes++;
            } else {
                maxOnes = max(maxOnes, currentOnes);
                currentOnes = 0;
            }
        }
        maxOnes = max(maxOnes, currentOnes);
        return maxOnes;
    }
};
```

Participants: Navinraj Saritha, Praveen H.O., Anshu P., Anshu Aham, Abhilash Gk

Participants in the meeting gallery:

- n: Raju Acharya
- r19ec049@reco.r...: r19ec049@reco.r...
- J: Jyothsna k gowda
- K: Karthik Kadar
- C: Chinna Ashwin
- Shwetha A: Shwetha A
- H: Harshitha Umahant
- Sanika Agte: Sanika Agte
- M: Monika D
- R: RAGHU RATNA
- Suman S N: Suman S N
- charan: charan
- bhargavi r: bhargavi r
- M: Manoj M
- AROMAL A.J: AROMAL A.J
- V: Venkatesh V
- k: kachanath nagarath
- S: Sheharyar F S
- M: MOHAMMAD BILAL
- A: Ajmal Khan
- R Arun Kumar: R Arun Kumar
- M: Mahesh Kumar X
- Chitimreddy Ch...: Chitimreddy Ch...
- Maharath P: Maharath P

REVA UNIVERSITY  
Bengaluru, India

**Capturing the event:**

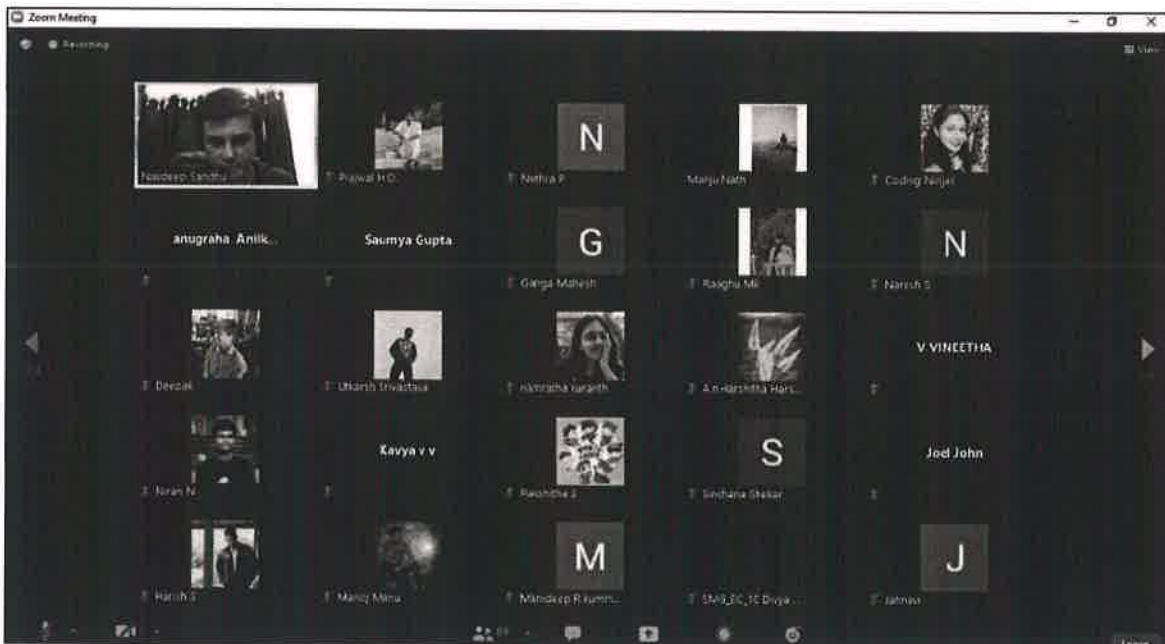
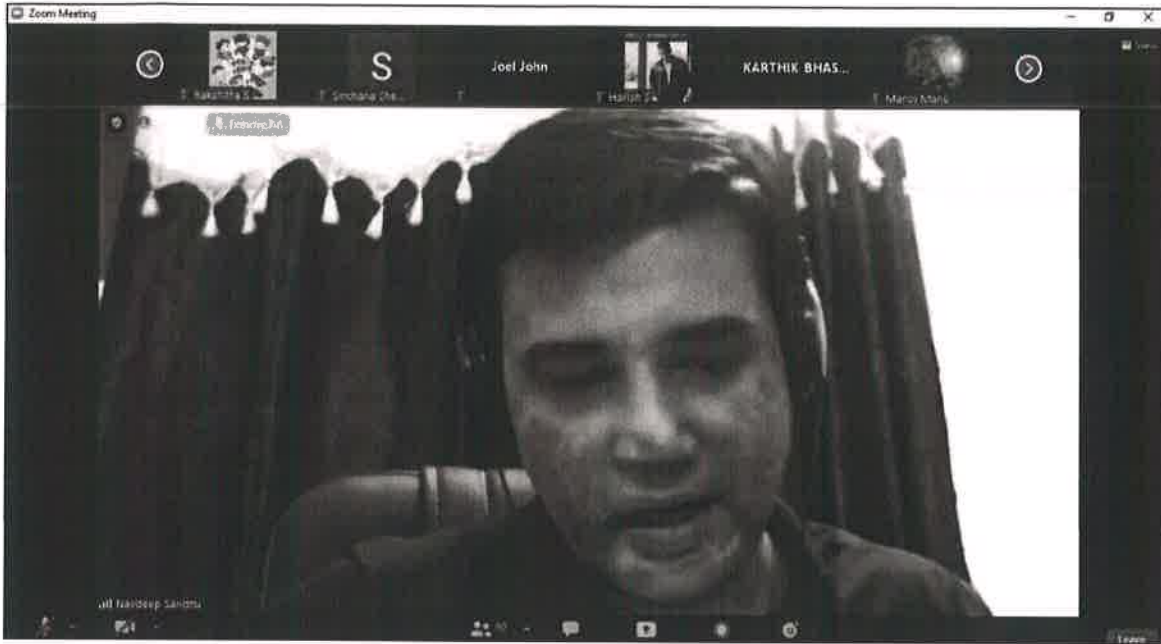



**REVA**  
**UNIVERSITY**  
BENGALURU • INDIA

**School of Electronics and Communication  
Engineering**

**Coder's Club Presents a webinar on  
"ROADMAP ON CRACKING  
INTERNSHIPS AND PLACEMENTS  
INTERVIEWS".**

The School of Electronics and Communication Engineering in association with Coder's Club successfully conducted its event "Roadmap on cracking internships and placements interviews" on 5th of June, 2021 through a webinar. Delegates attending the program were Director, School of ECE, students from REVA University in the presence of faculty coordinator Prof. Chaitra Nayak J.

The webinar was conducted by Instructor and content Developer of Coding Ninjas Mr. Navdeep Sandhu. More than 120 students from REVA University actively attended the session.

The webinar began at 11:00AM where all the attendees were asked to join 10 minutes prior to the meeting. The duration of the event was one hour. Students were highly enthusiastic about this event. The Event began with Miss Nethra giving the welcome speech and Vice President Niran briefing about the coder's club and Director guiding the students. The event came to an end with discussion of doubts among students and resource person.

This webinar will be helpful for a student in any year to have a clear idea about "how to prepare for their interviews?". The session was interactive, and students cleared their doubts to the speaker. The speaker has helped over 1000+ students motivating them to get into their dream companies. The students were immensely benefited from the webinar.

We would like to thank our beloved Chancellor, Vice Chancellor for providing all the facilities and support to conduct this program. We also thank our Director, School of ECE, Dr. R.C. Biradar and Assistant Director Dr. Sudarshan K M for their constant support and guidance.



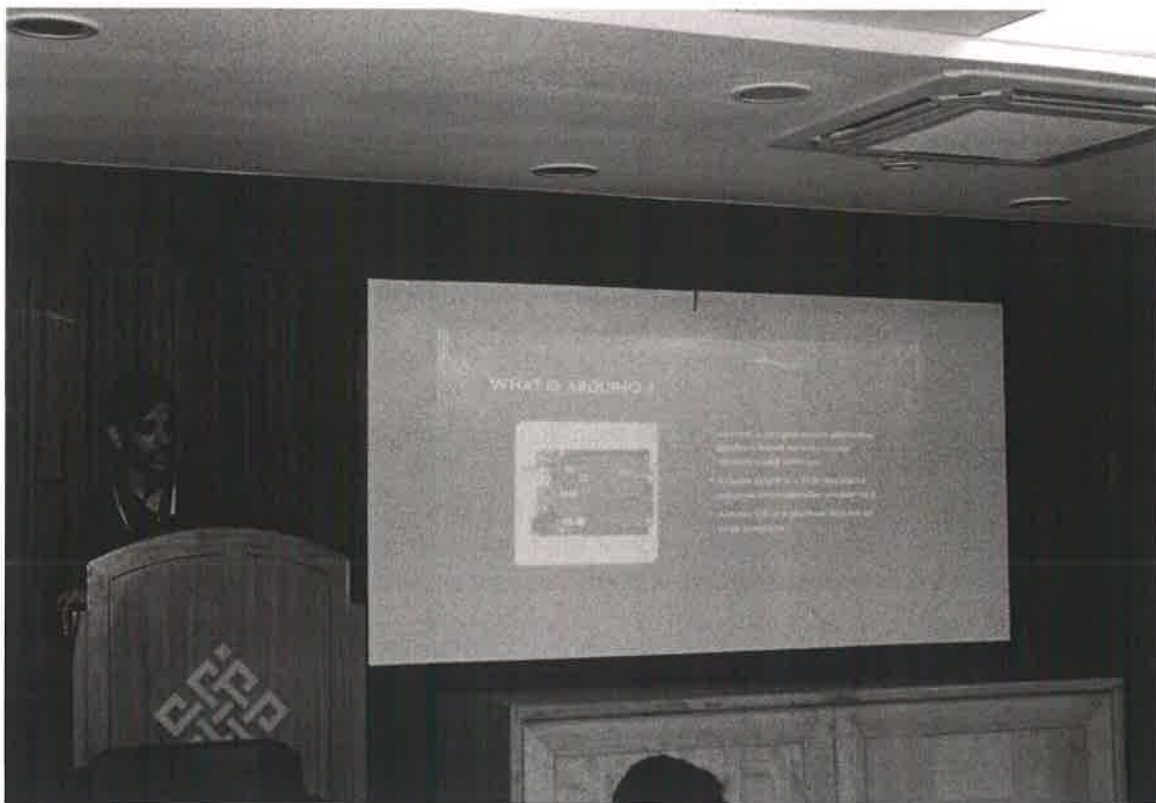

  
**Director**  
School of Electronics &  
Communication Engineering  
REVA University, Rukmini Knowledge Park  
Kattigenahalli, Yelahanka, Bengaluru - 560 064

**School of Arts & Humanities**

**Event: Prepared speech competition**

**Date: 22 Sep. 2020**

Toastmasters Club, School of Arts and Humanities of REVA University conducted prepared speech competition on 22 September 2020 through online conferencing platform (Microsoft Teams). There were 22 participants. Students from various programmes participated in the event with great fervour and enthusiasm. It was an individual event. Every participant had to speak for 60 to 90 seconds in English, Kannada or Hindi. The criteria for judging were content and delivery of the speech. The event made the students to be more confident,. The students also understood the importance of public speaking.

The Faculty Coordinator were Prof. Ajesh C (English), Dr. Prasanna (Kannada), and Dr. Maya (Hindi). The judges for the event were Prof. Shompurbha, Prof. Lingappa, Dr. Prasanna, Dr. Maya and Prof. Ajesh C. The winners were (English): R Vishal, 1BA (JEP) (First), Mohan Vamshi. P, 1B Com (H) (Second), Deepa Kaur 1 BCom (H) (Third); Kannada: Santhrupthi S S, 3BSc PCM (First), Dhanushree , 3 BSc BBG (Second); and Hindi: Anu Singh, 3BA (First). The students expressed their joy and excitement for having a platform to polish their public speaking skills. They were very excited to participate in the upcoming events of the club.

Link: <https://web.microsoftstream.com/video/ce6e7f3d-b208-4a5a-80a6-ff193ab30686?st=35>

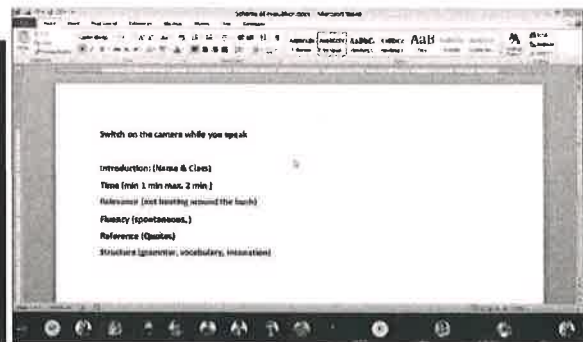
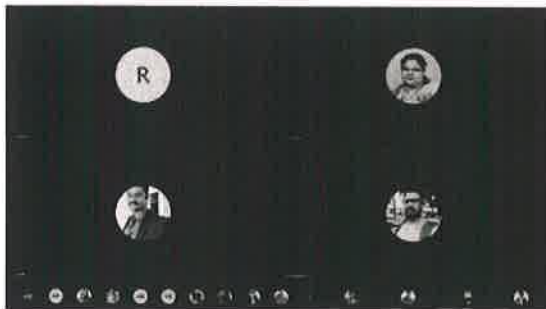



  
**Director**  
School of Arts, Humanities  
& Social Sciences  
REVA University, Rukmini Knowledge Park,  
Mattigenahalli, Yelahanka, Bangalore-560064



**REVA**  
**UNIVERSITY**  
Bengaluru, India

## **School of Arts, Humanities & Social Sciences**

### **LITERARY CLUB**

20<sup>th</sup> April 2021

### **CIRCULAR**

#### **ACTIVITY – Story Telling**

**Date: 21<sup>st</sup> April 2021**

**Tim: 3.30 p.m.**

**Platform: Microsoft Teams**

**Note:**

- It is an individual event.
- The participant can tell story in any one of the three Languages.
- **English, Kannada or Hindi**
- Criteria for judging: Content, Language and Presentation.
- Registration closes on 21<sup>st</sup> April 2021 at 2:30 p.m.

Interested students can register your names with the following Faculty Coordinators through WhatsApp.

1. Prof. Lingappa (9880470906)
2. Dr. Maya (9449987351)
3. Prof. Nasreen Ghani (9901083286)

  
**Director**

**Director**

**School of Arts, Humanities  
& Social Sciences**

REVA University, Rukmini Knowledge Park,  
Kattigenahalli, Yelahanka, Bangalore-560094



## School of Arts, Humanities & Social Sciences

**Event: Story Telling Competition**

**Date: 21<sup>st</sup> April 2021**

Literary Club, School of Arts, Humanities and Social Sciences of REVA University conducted Story telling competition on 21<sup>st</sup> April 2021. Students from various schools participated in the event with great fervor and enthusiasm.

Students came up with brilliant stories from Mahabharatha to moralistic and also stories with interesting twists. Audience thoroughly enjoyed the session. The judges and the faculty coordinator gave guidelines regarding the rules and time management.

It was an individual event. Every participant's story was judged on the criteria of content, language and presentation skills. The Faculty coordinators were Prof. Nasreen Ghani, Prof. Lingappa and Dr. Maya. The judges for the event were Dr. Anupama B N and Dr. Prassana. About 20 students participated in the event. The judges were felicitated and vote of thanks was presented by Prof. Lingappa.

The stories were evaluated on the fixed criteria and the result was as below:

Vishal –BA-JEP II Semester (English)

Vaishnavi – BSc – PCM IV Semester (Kannada)

Rajnandini – BA – JEP II Semester (Hindi)

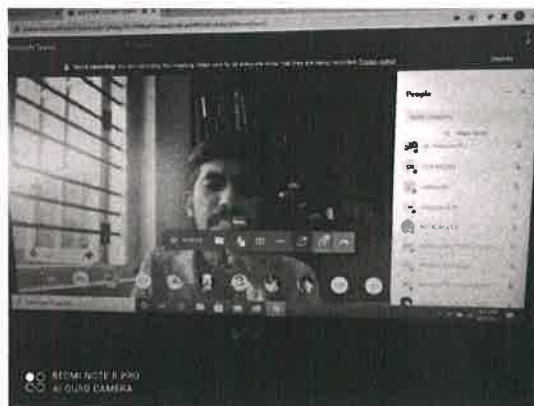



REVA  
UNIVERSITY

Bengaluru, India

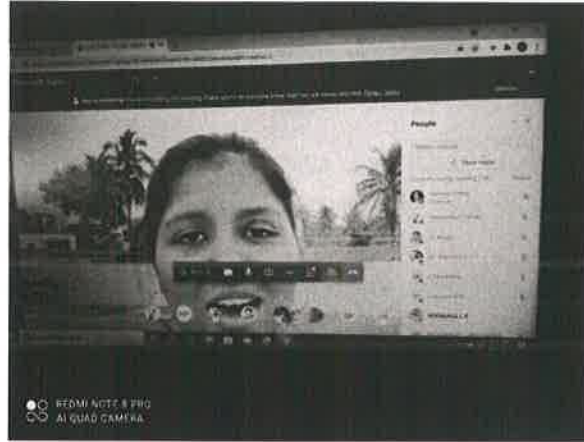

Director

School of Arts, Humanities  
& Social Sciences

REVA University, Rukmini Knowledge Park,  
Hehalii, Yelahanka, Bangalore-560064



**E-Quiz on the occasion of World Environmental Health Day.**

**Club name: Eco Club**

**Date: 19.9.2020 to 26.9.2020**

**Number of participants: Inhouse - 75.**

**Activity Conducted:** World Environmental Health Day is celebrated every year on September 26<sup>th</sup>. Every year there will be a specific theme for world environmental health day. The theme for this year is “ENVIRONMENTAL HEALTH, A KEY PUBLIC HEALTH INTERVENTION IN DISEASE PANDEMIC PREVENTION”. To commemorate this, Department of Biotechnology, School of Applied Sciences organized an online E-Quiz on the occasion of World Environmental Health Day.

E-Quiz is organized to create awareness about environmental health aspects among our university students and also to increase student knowledge horizons. 76 students have participated in this open quiz event and immensely benefitted from this activity.

**Photographs:**

The poster features the REVA University logo and name at the top left, with accreditation details below it. On the top right, there are logos for IGWUE Gold, NIRF, Institution's Innovation Council, MHRE'S INNOVATION CELL (GOVERNMENT OF KARNATAKA), and KSURF. The central text reads: 'School of Applied Sciences, Department of Biotechnology Organises on the occasion of World Environmental Health Day E-quiz on World Environmental Health Organisers'. Below this, contact information for Prof. Shilpa B R and Dr. Santharam K S is provided. At the bottom, the date 'Date: 19<sup>th</sup> to 24<sup>th</sup> September, 2020', the quiz link 'Link for quiz: https://bit.ly/3kw11P', and the website 'www.reva.edu.in' are listed.

Signature of coordinators

Signature of the HOD

Deputy Director  
School of Applied Sciences  
REVA University, Rukmini Knowledge Park  
Kattigenahalli, Yelahanka, Bangalore - 64

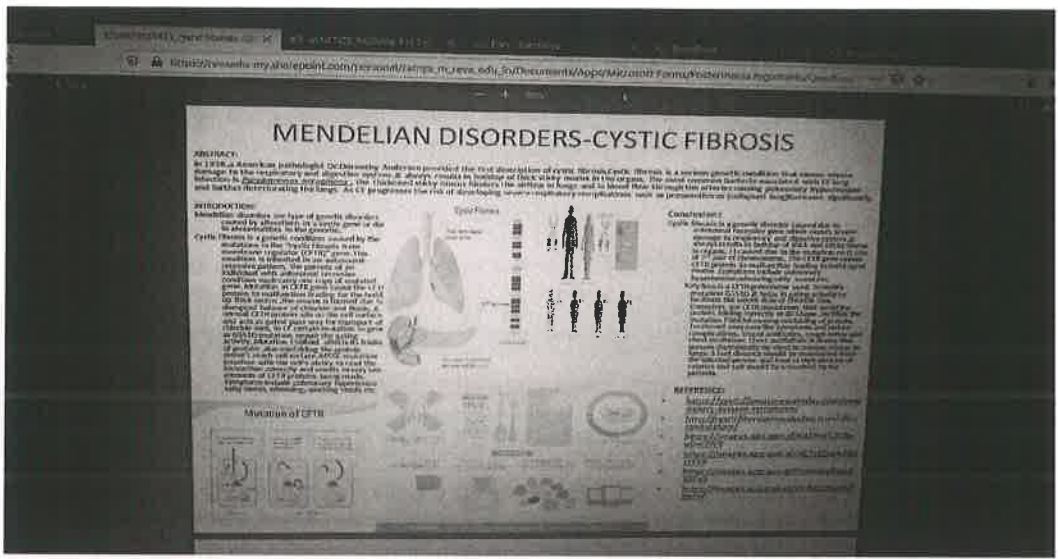

Activity – Webinarrest – webinars presented by participants

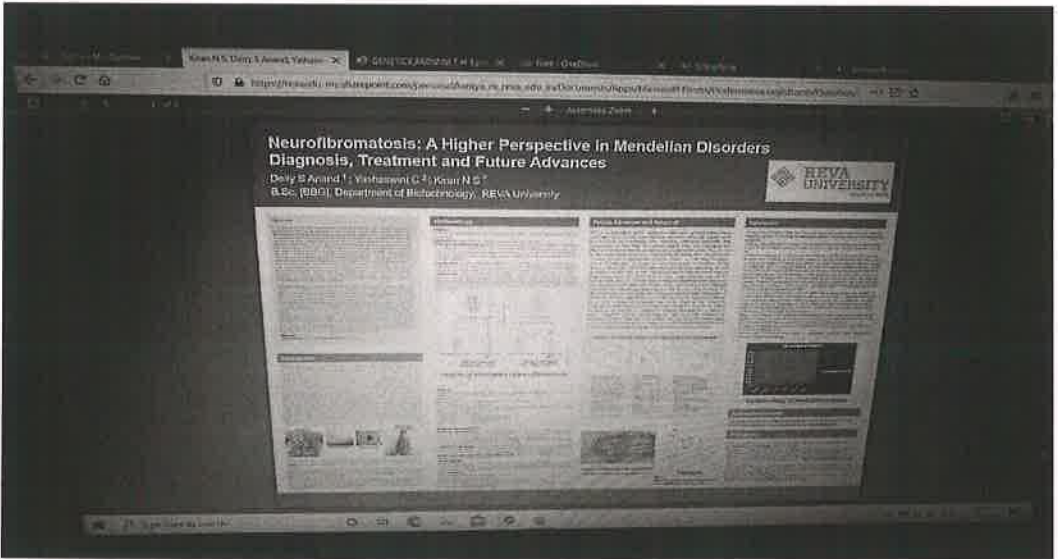

Activity – Postermania – e-posters presented by participants.

Signature of coordinators

Signature of the HOD

Deputy Director  
School of Applied Sciences  
REVA University, Rukmini Knowledge Park  
Kattigenahalli, Yelahanka, Bangalore - 56





**Club name: X-Heme**

**Date: 17.03.2021**

**Number of participants: 30**

**“Activity-Health Camp”**

Department of Biochemistry, School of Applied Sciences organized a Health camp at the Govt. Primary School, Huttanahalli, Bengaluru on 17<sup>th</sup> March 2021. Prof. Deepa, Dept of Biochemistry gave talk with PPT on the importance of hygienic and nutrient food. She interacted with students about covid-19 awareness and gave tips to maintain good health. Students of BMLT checked height, weight and other details of the student and recorded. Dr. Arun did general physical check up of all students and Dr. Lavanya did dental check up of all students and details were reported.



Prof. Deepa interacting with Students



The physician and dentist examining the children

## IPR session-skill development program

**Club name:** Idea Club

**Date:** 16/10/2020 & 17/10/2020

**Number of participants:** Inhouse – 150.

### Activity Conducted:

UIIC, REVA University in association with School of Applied Sciences, Department of Biotechnology conducted a session on IPR in Life Sciences on 16<sup>th</sup> and 17<sup>th</sup> of October for the students of BSc Biotechnology, 5<sup>th</sup> sem and III Sem MSc Biotechnology. 150 students attended the session. The resource person for the session was Rathan, Corporate Executive and Trainer, UIIC. Detailed account of different types of IPR and its implications in Biotechnology was given by the resource person. The modules of the session included following topics: Introduction on Patents and Copyrights, Importance and Significance of IPR and Copyrights, Trademark, Trade-secret, Design, Geographical Indications, Implications in Life Sciences. The procedure for patenting was also explained. The major emphasis was given to the patent in Life science domain with relevant examples from Biopharma companies. Patenting of Genetically modified organisms was discussed in detailed. The concept of provisional patenting which is very relevant for student community was also discussed. The session was highly interactive and productive. All the queries of the students were answered by the resource person.

### Photographs:

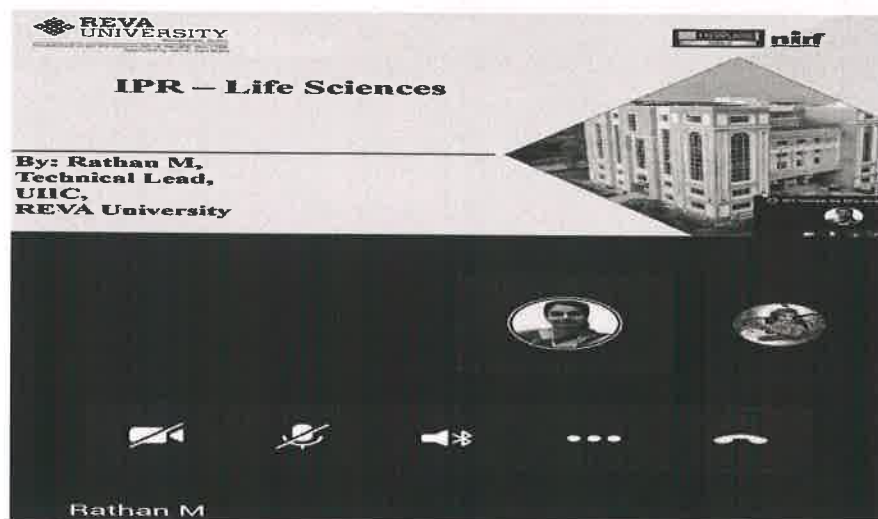

IPR Lifesciences – Skill development session

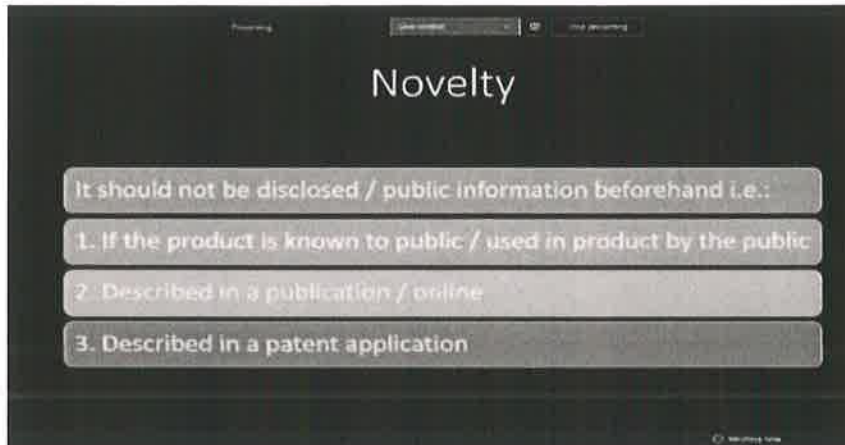

IPR session – novelty in the discovery

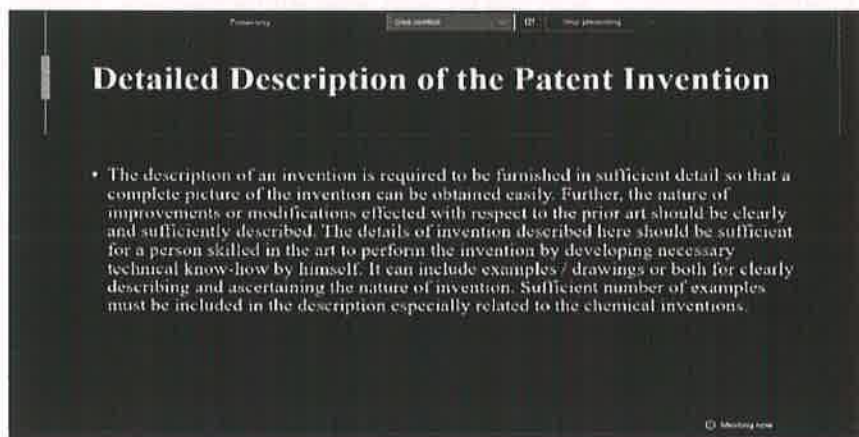

IPR session – Patent invention

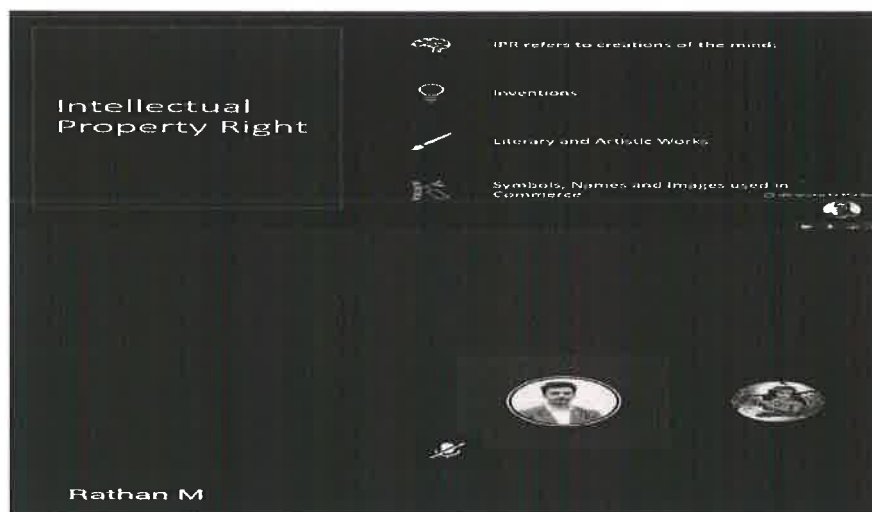

IPR Session – Emphasis on IPR and its protection

Signature of coordinators

Signature of the HOD  
 Deputy Director  
 School of Applied Sciences  
 REVA University, Rukmini Knowledge Park  
 Kattigenahalli, Yelahanka, Bangalore - 56

100

40



**REVA**  
**UNIVERSITY**

Bengaluru, India

**Webinar on “Intellectual Property Rights in Science”**

**Club name: Idea Club**

**Date: 22.04.2021**

**Number of participants: 215 Inhouse participants .**

**Activity Conducted:** Webinar on “Intellectual Property Rights in Science” was organized by Department of Biotechnology, School of Applied Sciences in association with REVA IPR Cell on 22<sup>nd</sup> April 2021 through MS Teams Platform. Prof. Renuka Madhu, IPR coordinator from the Department coordinated the event. The webinar was organized to create an awareness about various IPRs in the field of science among faculty members and students. Main aim was to give an insight regarding all the available patents and its importance for the certification of innovations under legal grounds.

215 participants, including Faculty members and Post Graduate students of SoAS attended the session from the Department of Mathematics, Chemistry, Physics, Biotechnology and Biochemistry. The session focused on 4 main themes such as IPR Awareness, Criteria for patenting, Different types of Patent Applications, Patent filing etc. The resource person presented a detailed idea of various sectors of patents and its applications.

Detailed account of Utility, Design and Process Patent was provided through the session along with the criteria for patenting such as Novelty, Non-Obviousness, Industrial Applicability etc. The session was very informative, interactive and productive. Resource person also guided the participants regarding patent search for novelty check and also suggested the web sites for patent search. Students were advised to check their project work in terms of patentability before publishing in Journals.

**Photographs:**

The banner features the REVA University logo and name at the top left, along with accreditation logos (UGC, NIRF, KSURE, ARHA) at the top right. The central text reads: "University Industry Interaction Center in association with School of Applied Sciences, Department of Biotechnology Organises a Webinar on Intellectual Property Rights in Science". Below this, it lists the Resource Person as Arshiya Ambreen, Corporate Executive & Trainer at REVA University, with contact details: E-mail: arshiya.ambreen@reva.edu.in • Mob: 96115 14885. The Organizer is Prof. Renuka Madhu, Associate Professor and IPR Coordinator at the Department of Biotechnology, SoAS, REVA University, with contact details: E-mail: renuka.madhu@reva.edu.in • Mob: 94817 75350. At the bottom, it provides the Date (22<sup>nd</sup> April, 2021), Time (10:30 A. M. to 11:30 A. M.), MS Team Link (https://bit.ly/3tCe3yA), and the website (www.reva.edu.in).

Banner – IPR in Science





**Contents of Specification**

- Title of the patent invention
- Background of the invention
- Summary of the invention
- Explanation if any of the patent drawings
- Description of the invention
- Patent Claims
- Patent Abstract of the disclosure
- Sequence listing, if any

**Patent contents**

**Types of Patents Granted in India**

- Provisional Application
- Ordinary / Non Provisional Application
- Convention Application
- PCT International Application
- PCT National Phase Application
- Patent of Addition
- Divisional Patent Application

**Types of patents**

Signature of coordinators

Signature of the HOD

Deputy Director  
School of Applied Sciences  
REVA University, Rukmini Knowledge Park  
Kattigenahalli, Yelahanka, Bangalore - 56



## Ideathon 1.0

**Club name: Idea Club**

**Date: 29.5.2021**

**Number of participants: 80** Inhouse and Outside students.

**Activity Conducted: The Theme of the ideas include** medical devices, Natural and synthetic products, Food and Nutrition, Eco-friendly material preparation, Waste management, medical waste management, Life science in space exploration, Biophysics, Biofuel, Bioenergy, Pharmaceuticals, Agricultural Technology, Energy and sustainability, Nanotechnology, and any other domain in science. We received 17 startup ideas and 6 patentable ideas from REVA University B.Sc. & M.Sc. Biotechnology, M.S Ramaiah college of Arts and Science students are applied to the Ideathon competition. The jury members are screened all the ideas and provided the scores for the second round of screening process. The information is intimated to the best selected participants. All jury members have given the marks to the selected 8 best presentations. The final winners is announced with 3 best presentations. The remaining participants are selected for Incubation in REVA Nest based on the terms and conditions of the REVA Nest Policies. Here is the list of winners and incubation facility accepted participants.

### Photographs:

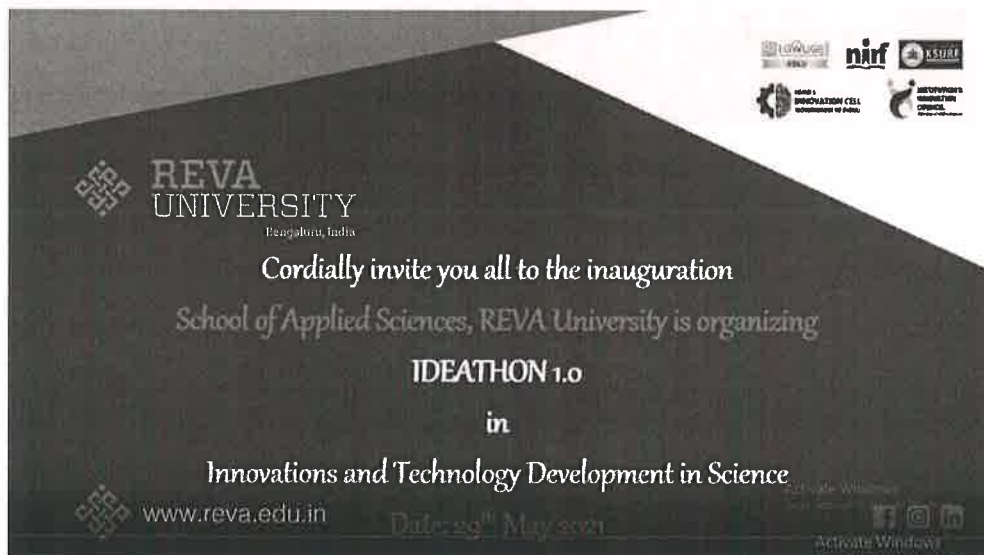

Banner – Ideathon 1.0



**REVA**  
**UNIVERSITY**

Bengaluru, India

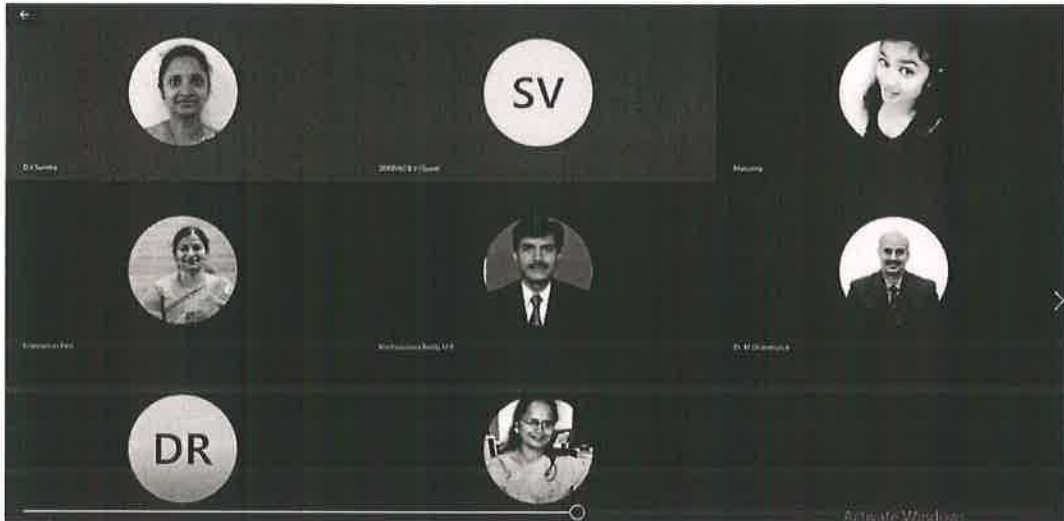

Online mode -participants



Address by Vice Chancellor Sir

Signature of coordinators

Signature of the HOD

Deputy Director  
School of Applied Sciences  
REVA University, Rukmini Knowledge Park  
Kattigenahalli, Yelahanka, Bangalore - 64

**Club name: Bioquimica**

**Date: 23.12.2020**

**Number of participants: 160**

**Webinar on “PCR Based Diagnosis for infectious diseases”**

The Department of Biochemistry, School of applied sciences organised a one day Virtual webinar on “PCR Based Diagnosis for infectious diseases” and was scheduled on 23rd December 2020, from 10.00 AM to 11.00 AM. The Resource Person for the webinar was Dr.Karthi Natesan, Post Doctoral Research Associate, Rural Development administration, Jeonju, South Korea. Around 160 students of M.Sc Biochemistry, M.Sc Biotechnology and B.Sc MLT students of REVA UNIVERSITY attended the webinar online. The webinar gave a very insightful knowledge on types of PCR, methodology and its applications in the diagnostic field to identify the COVID- 19.All the faculty and students actively participated in the webinar. Feedback was been taken by the students and staff after the webinar was been concluded.

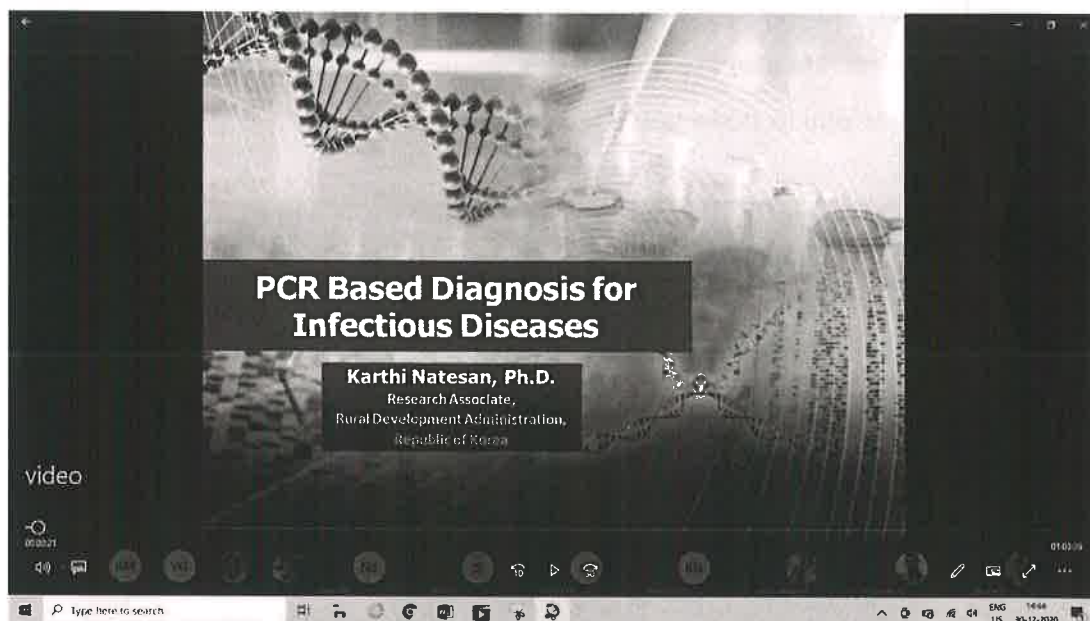

Introduction slide of Dr. Karthi N for the webinar



**Club name: Bioquimica**

**Date: 08.06.21**

**Number of participants: 200**

**A Virtual Symposium - Systematic Application of Chemical Nano Science and Metabolomics in near Future**

The School of Allied Health Sciences had organized a **virtual Symposium on Systematic Application of Chemical Nano Science and Metabolomics in near Future on 08/06/2021**. The event was presided over by our Chancellor Sir, Dr. P Shyama Raju and Vice Chancellor Dr. M Dhanamjaya.

The first session was from 9:15 – 10:15 by **Dr. Paramasivam N, Senior Scientist, Drug Metabolism, Abbvie, California, USA**. Sir delivered a lecture on **the Recent and Future prospects of Metabolites profiling in early clinical development**, and also he explained the importance of Ubiquitin with drug metabolites. The next session was at 10:30 to 11:30 am on **” Sophisticated analytical techniques-based Metabolic profiling”** by **Dr. Vimalraj Mani**, who is a senior postdoctoral research associate in metabolomics department at Rural Development Administration, South Korea. One of the finest Korean govt. research institute under Food and Agriculture ministry. Who has specialized in metabolomics engineering and profiling of wide range of plant species. He holds his doctorate from Jeonbuk National University, South Korea. The third session started at 11:45 am to 12:45 pm on **“Novel Visible light driven photocatalyst for environmental and biomedical application”** by **Dr. Harshavardhan, Mohan**, an Indo- Singaporean descendant is an ambitious researcher working as Postdoc in Jeonbuk National University, South Korea, striving to promote environmental biotechnology for he has been nature person.



**REVA UNIVERSITY**  
Bengaluru, India  
Established as per the Section 2(f) of the UGC Act, 1956  
Approved by AICTE, GOA and PCI, New Delhi

School of  
Allied Health Sciences

Organizes Virtual Symposium on  
**Systematic Applications of  
Chemical Nano Sciences  
& Metabolomics in near Future**

Speaker:  
**Dr. Harshavardhan, Mohan**  
Department of Chemistry  
College of Natural Science  
Jeonbuk National University, South Korea  
Title: Novel Visible Light Driven Photocatalyst for  
Environmental and Biomedical Application

Date : 8<sup>th</sup> June, 2021  
www.reva.edu.in

Banner for the session

Deputy Director  
School of Applied Sciences  
REVA University, Rukmini Knowledge Park  
Kattigenahalli, Yelahanka, Bangalore - 54

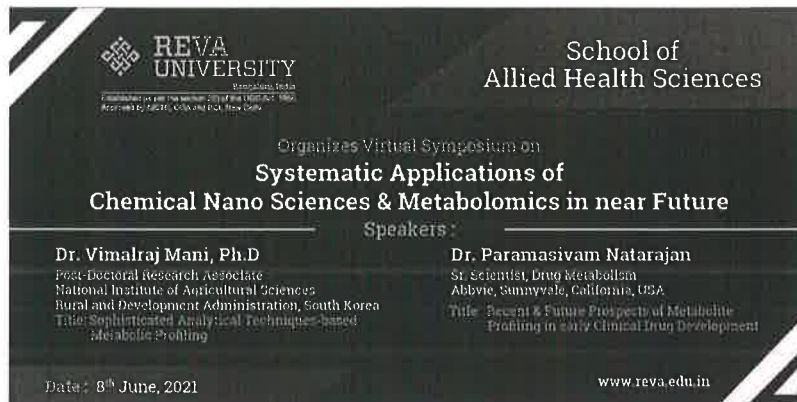

Banner for the Symposium

**Club name: Bioquimica**

**Date: 25.06.21**

**Number of participants: 90**

**“GENERAL PRINCIPLES OF CANCER, INCIDENCE AND TREATMENT”**

Department of Biochemistry organized a Health Talk titled **“General Principles of Cancer, Incidence and Treatment”** on 25/06/21 on Microsoft Teams. The resource person was Resource Person was Dr Ajay Rao P, Chief consultant Radiology oncologist, Cytecare Cancer Hospitals. Around 90 students and faculty members of the school attended the webinar. He introduced the General principles of cancer. He explained about the 5 most prevalent cancers globally. The different treatment methods were explained. Many myths about Cancer were discussed and the reality was explained. He ended by telling that Cancer is a disease that breaks rules. The attendees also consulted him with their diagnostic reports and got their doubts clarified.



Deputy Director  
School of Applied Sciences  
REVA University, Rukmini Knowledge Park  
Kattigenahalli, Yelahanka, Bangalore - 56

112

46

**School Name: School of Allied Health Sciences**

**Club name: Bioquimica**

**Date: 14.06.21**

**Number of participants: 160**

The School of Allied Health Science organized one Webinar on 14/06/2021 by 9.30 am, The Resource person Dr Paramasivam.N, Sr.Scientist, Drug Metabolism, Abbvie, California, USA. Dr Paramashivam., Delivered a lecture on Targeted Protein degradation: A drug Discovery perspective and also he explained about the importance and role of PSP Protein in Drug degradation And also he explained the importance of Vitamin derivative like Ubiquitin and how it involved in Drugmetabolism. For this nearly 160 students from UG and PG attended.

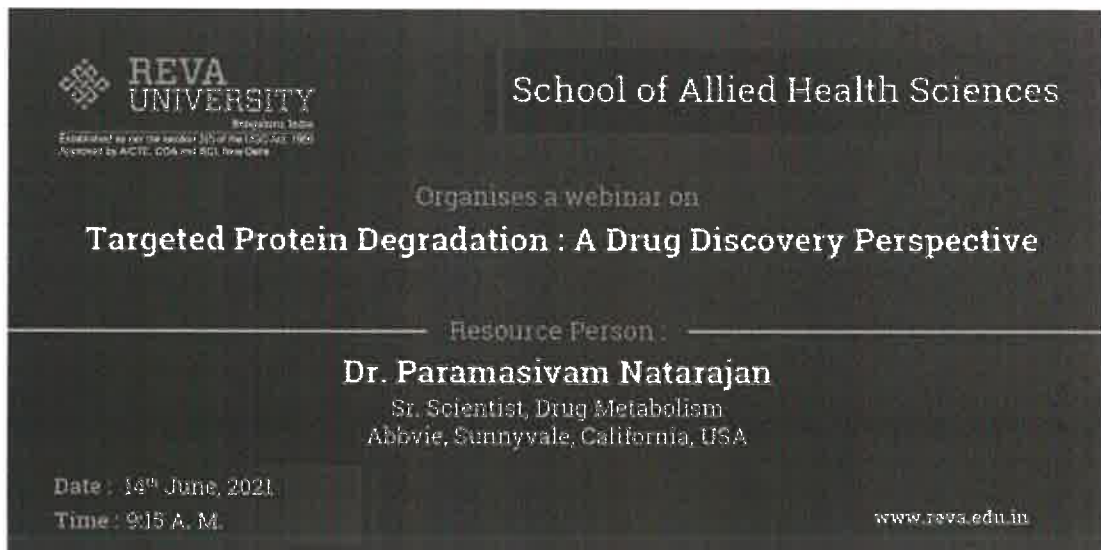

The banner features the REVA University logo on the left, which includes the text 'REVA UNIVERSITY', 'Bengaluru, India', 'Established as per the order JN of the U.S.G. Act, 1960', and 'Approved by AICTE, DDE and AGL, New Delhi'. To the right of the logo, it says 'School of Allied Health Sciences'. The main text in the center reads 'Organises a webinar on Targeted Protein Degradation : A Drug Discovery Perspective'. Below this, it identifies the 'Resource Person' as 'Dr. Paramasivam Natarajan', 'Sr. Scientist, Drug Metabolism, Abbvie, Sunnyvale, California, USA'. At the bottom left, it specifies 'Date : 14<sup>th</sup> June, 2021' and 'Time : 9:15 A. M.'. At the bottom right, the website 'www.reva.edu.in' is listed.

Banner



Deputy Director  
School of Applied Sciences  
REVA University, Rukmini Knowledge Park  
Kattigenahalli, Yelahanka, Bengaluru



**REVA**  
**UNIVERSITY**

Bengaluru, India

Established as per the section 2(f) of the UGC Act, 1956,  
Approved by AICTE, New Delhi

## **Webinar Report on Careers in Solar Roof Top**

**School: Mechanical Engineering**

**Venue: M.S.Teams (Online)**

**Date: 27/09/2020**

**Year: 2020-21**

### **Brief Introduction to Resource Person:**

K Nazeem has obtained B.E, he is an Entrepreneur. Learner, Education & Skill Developer, Research Facilitator, Biking & Wild Life Enthusiast. He is the Founder and CEO at Kamati Research Foundation, A serial Entrepreneur with 25 years of experience in the field of Renewable Energy , Mining, Water, Education and Advisory services.

He has served more than 4000 clients like MNCs, Industries, Educational Institutes , Overseas and Domestic . He is Deputed by NSIC ( Govt of India) as an “ Technology Expert” to Govt of Zimbabwe, for the Solar Incubation Project, in the year 2017. He is also successfully trained students of Moulana Azad National Urdu University ( MANUU) in the Solar Power Plants and Developed the 100% Solar Computer Lab for the reputed institutes.

He is also initiated the Research Oriented activities after the launch of KRF – ( Kamati Research Foundation) focusing the Students and Entrepreneurs. He has Interested and attended TRIZ ( Russian Innovative Problem solving Methodology)

### **Brief details about the Webinar:**

This Webinar organized under the student chapter of Solar Energy Society of India “SESI”. This webinar exclusively for the student members of SESI of REVA University. This



Webinar will help to get more knowledge on careers involved in solar energy. Based on some final year student request, given permission to attend final year student. This webinar focussed present career point of view.

This Webinar highlighted the careers involved in various sectors of solar energy i.e. in manufacturing, service and R&D. Webinar also addressed how to solarize a house with 1 kW power and various components required to install, cost of installation etc. It is plat form for further making MOU with solar organization to train the students to build and service solar power plants. As Green and future energy is Solar hence knowledge on training and equipping the solar equipment discussed. Recent development in solar battery and solar panels explained in detail. Precent research topics and work carried out on solar power till now addressed in the webinar.

The Webinar started with welcome speech by our beloved Director K S Narayanaswami, he briefed the importance of solar energy and webinar. Prof. Richa introduced about the resource person. The webinar conducted for 45 minutes and 25 minutes discussion. Around 75 members participated in the webinar.

**Takeaway from the Webinar are:**

1. Basics of the solar energy
2. How to solarize homes
3. Careers in Solar Rooftops
4. Interest Free finance for Entrepreneurs

**Regsitrations and Attendees List :**

Webinar on careers  
in Solar roof top Regt

**Feedback:**

**E-Banner:**

**REVA UNIVERSITY**  
Bengaluru, India  
Accredited by AICTE, NIRF, ISO 9001

**School of Mechanical Engineering**  
in association with the **SESI Student Chapter**  
Organises

# Webinar on Careers in Solar Roof Top

**Resource Person**  
**K Nazeem**  
Founder and CEO  
KRF KAMATI Green Tech LLP  
Bengaluru

**Highlights of the Webinar**  
Basics of the Solar Energy  
How to Solarize Homes  
Careers in Solar Rooftops  
Interest Free Finance for Entrepreneurs

27<sup>th</sup> September, 2020  
Time: 11:00 A.M. to 12:00 P.M.

Registration link: <https://bit.ly/33QE2Gy> • No registration fee

[www.reva.edu.in](http://www.reva.edu.in)

**Gallery:**

Webinar on Careers in Solar Roof Top

Request control

Leave

12:44

REVA UNIVERSITY

**School of Mechanical Engineering**  
in association with the **SESI Student Chapter**  
Organises

# Webinar on Careers in Solar Roof Top

**Resource Person**  
**K Nazeem**  
Founder and CEO  
KRF KAMATI Green Tech LLP  
Bengaluru

**Highlights of the Webinar**  
Basics of the Solar Energy  
How to Solarize Homes  
Careers in Solar Rooftops  
Interest Free Finance for Entrepreneurs

27<sup>th</sup> September, 2020  
Time: 11:00 A.M. to 12:00 P.M.

Registration link: <https://bit.ly/33QE2Gy> • No registration fee

[www.reva.edu.in](http://www.reva.edu.in)

37

SH BS SS

Ajun Kumar

Madhu B.P.

U.S. Rajaguru Venky

RT



**REVA**  
**UNIVERSITY**

Bengaluru, India

Anis zulfiqhar hameed	anisetaamne@yahoo.com	Karnataka	9902804737
--------------------------	-----------------------	-----------	------------

**Webinar Registration link :** <https://bit.ly/33QE2Gy>

**Webinar Link for Session:** - [https://teams.microsoft.com/l/meetup-join/19%3ameeting\\_Y2ViZTc3OGYtNmZjZi00NTVjLWEyMTctMDdiOGNhMjE4YTky%40thread.v2/0?context=%7b%22Tid%22%3a%22474565c1-bca4-4295-a2f5-b0c7dbf2591c%22%2c%22Oid%22%3a%22de1f4f81-74cf-44f2-b6a7-ab16dd18d1a5%22%7d](https://teams.microsoft.com/l/meetup-join/19%3ameeting_Y2ViZTc3OGYtNmZjZi00NTVjLWEyMTctMDdiOGNhMjE4YTky%40thread.v2/0?context=%7b%22Tid%22%3a%22474565c1-bca4-4295-a2f5-b0c7dbf2591c%22%2c%22Oid%22%3a%22de1f4f81-74cf-44f2-b6a7-ab16dd18d1a5%22%7d)

**Feedback link:**

We would like to thank our beloved Chancellor, **Dr. P. Shyama Raju** for providing all facilities and support to conduct this program., Registrar, **Dr M. Dhanamjaya** for his continuous support.

We also thank our Director, School of Mechanical Engineering, **Dr. K S Narayanaswamy**, for his constant support and always motivating us to organize such events in School of Mechanical Engineering.

**Coordinators: Dr. Veerbhadrappa**

**Mr. Manjunath C**

**Mr Varun Kumar Reddy**

**Mr Arun Kumar Reddy**

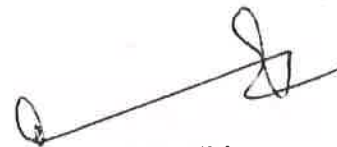
  
**Signature of the Director**



**Report on  
Five Days Virtual FDP on “Solar Energy-The Future is Bright”**

**School: Mechanical Engineering**

**Venue: Microsoft Teams (Online)**

**Date: 25/06/2020 to 29/06/2020**

**Year: 2019-20**

**Description of the Event:**

School of Mechanical Engineering in association with Solar Energy Society of India (SESI) organized five days FDP on “Solar Energy- The Future is Bright” from 25/06/2020 to 29/06/2020 for faculty members, industry personal and members of solar energy society. Around 210 participants got benefited from the FDP.

The resource person were

<b>Dr. Jagadish</b> Associate Professor, Mechanical Engineering and Science National Institute of Technology Raipur Raipur	<b>Dr. Santosh Kumar Hampannavar</b> Professor School of Electrical and Electronics engineering REVA University Bangalore
<b>Prof. L R Jagadeesh</b> Associate Professor School of Mechanical Engineering REVA University, Bengaluru	<b>Dr. Sayed Majid Ali Ali</b> Vice-President Solar Energy Society of India





The winners of the Doodle art are:

Position	Names	School
I	Aneeshwar Padmanabh D	ME
II	Amrita Singh	Applied science
III	Monika M And Sibghat Fatima	ME and CSE

The Winners of the Comic art are:

Position	Names	School
I	Syeda Nikhat Fatima	AR
II	Joshua Nnithin J	ME
III	Rahul C Reddy	ME

Registration Link: <https://forms.gle/Jvzq2Sf786HjA2JP6>

Feedback Link: <https://forms.gle/joUD125qBRVG7fR28>

We would like to thank our beloved Chancellor, Dr. P. ShyamaRaju sir for providing all facilities and support to conduct this program. Vice Chancellor, Dr M. Dhanamjaya sir for his continuous support.

We also thank our Director, School of ME, Dr. K S Narayanaswamy and Dr.Mahesh L, HoD of Mechanical Dept. for their constant support and always motivating us to organize such events in School of ME.

Faculty advisor of the Club:  17/8/21  
Dr. Niranjana Hiremath

Student organizers: 1) Mr. Astheek G Nadig 2) Mr. Karthik S 3) Ms. Danlyn Pearsila P

Report done by: Ms. Srushti G N

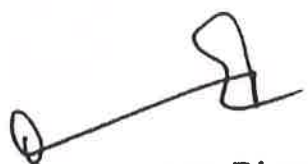
  
Signature of the Director  
Director  
School of Mechanical Engineering  
REVA University  
Rukmini Knowledge Park, Kattigenahalli  
Yelahanka, Bengaluru - 560 064



## Report on Quiz Event

### InQuisz-2k21

An Event that sparks the thinking on “Puzzles, Riddles, Apti and GK”

**School:** Mechanical Engineering

**Venue:** Seminar Hall, Sir M V Block, School of Mechanical Engineering

**Date:** 01/04/2021

#### ABOUT PROGRAM:

The event comprising of Puzzles, Riddles, Apti and GK was conducted for students across the university and 27 teams have participated in the event under The Inquidity Club of Mechanical Engineering.

A set of questions were given to the teams in the 1<sup>st</sup> round and top 8 teams are taken to 2<sup>nd</sup> round. Second round consisted of 3 sub rounds wherein they teams were asked to guess flags, logos, places, puzzles, General Knowledge.

#### List of Participants:

Sl.No	Names of the Participants	School
1	Chethan Rao Komal Suhas	C& IT
2	THEJAS SHEKHAR YASH AGARWAL SUHAS KS	Mechanical
3	Adarsh B Likhitha M Malavika S	ECE
4	Sahana S Monisha S Shashank M B	ECE
5	Vishal Kumar waghmore Vishwaradhya kollur	Mechanical



**REVA**  
**UNIVERSITY**

Bengaluru, India

**Glimpses of the Event:**

THE INQUISITY CLUB  
SCHOOL OF MECHANICAL ENGINEERING  
*Presents*  
**INQUISZ  
2K21**  
*"An event that sparks your thinking on  
Puzzles, GK, Riddles, Aptitude"*

**Event is  
On 1st  
April, 2021**



Scan the  
QR Code for  
Registration

*Registration is free and Participation  
Certificates will be provided*

**For any Queries  
Contact - 7382611298**

@inquisityclub

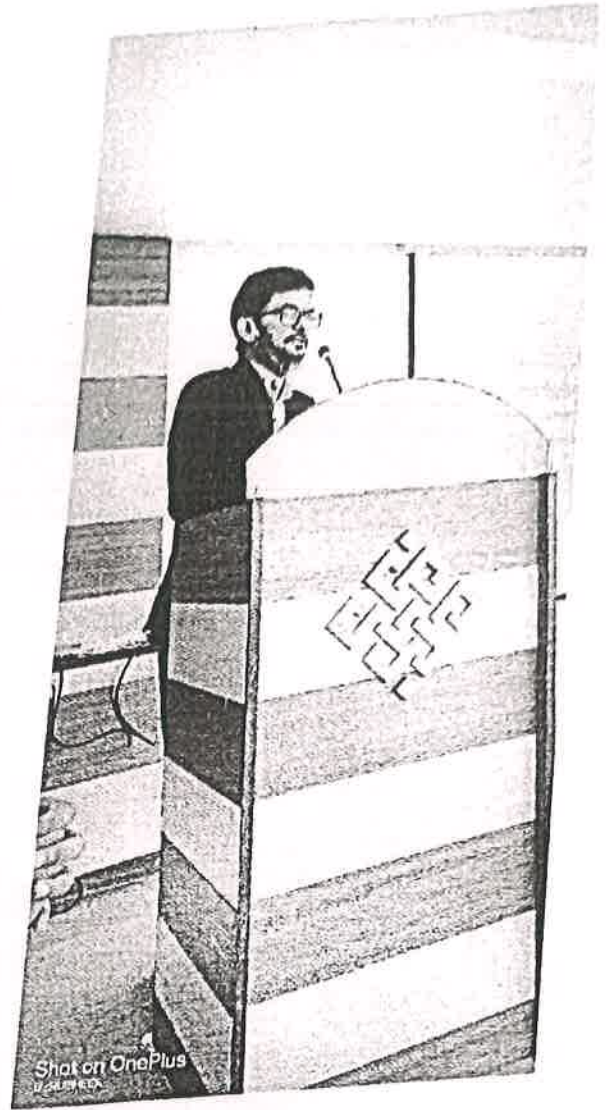





**REVA**  
**UNIVERSITY**

Bengaluru, India

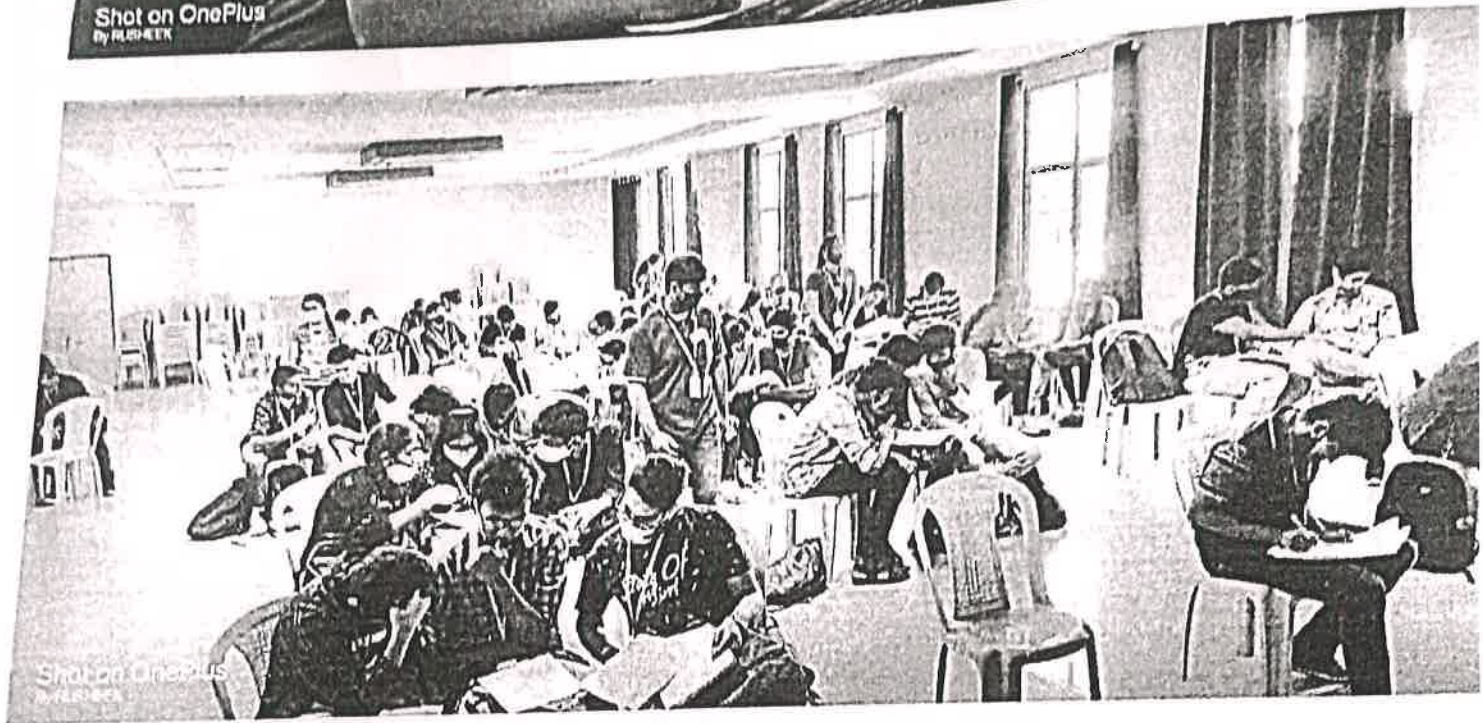
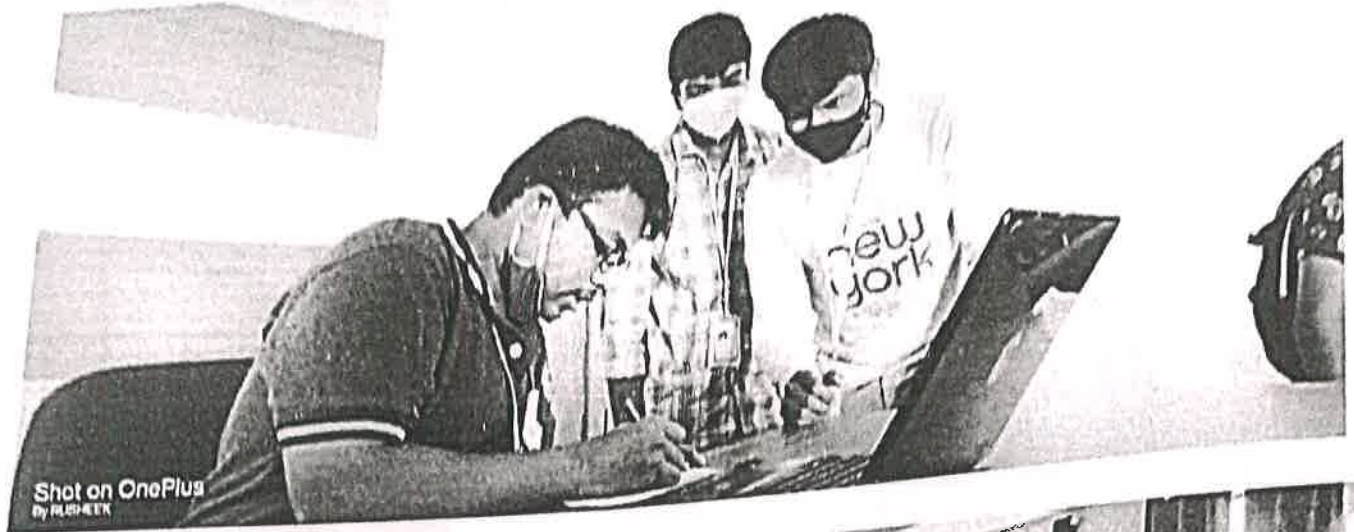



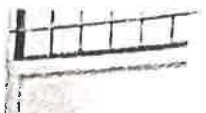
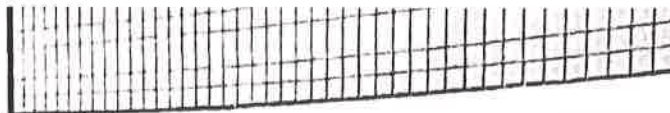









REVA  
UNIVERSITY

Bengaluru, India





**The Winners of the Event are:**

Position	Names	School
I	1) Merry Kashyap 2) M K Omkar 3) Akshar Radhakrishnan	M.Sc. BioTech
II	1) Sajeel Ahmed 2) Satyender Pal Singh	Mechanical
III	1) V Chandana 2) Zakiya Shabnam H R 3) Shraddha S Magaji	Mechanical and CSE

**Registration Link:** <https://forms.gle/wvo632NYQ4ucdZeh7>

**Feedback Link:** <https://forms.gle/p5HyM14TxMoD6SAE7>

We would like to thank our beloved Chancellor, **Dr. P. Shyama Raju sir** for providing all facilities and support to conduct this program., Vice Chancellor, **Dr M. Dhanamjaya sir** for his continuous support.

We also thank our Director, School of M E, **Dr. K S Narayanaswamy** and **Dr.Mahesh L**, Asst Director for their constant support and always motivating us to organize such events in School of ME.

Club Coordinator: **Dr. Niranjana Hiremath**  02/4/21

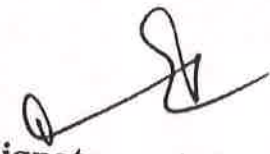
  
**Signature of the Director**  
School of Mechanical Engineering  
REVA University  
Rukmini Knowledge Park  
Yelahanka, Bengaluru - 560 064





**Attendees:**

1. K Rusheek
2. Manoj A B
3. V Dhanush
4. Kiran Vaithi
5. Manoj
  
6. Gouravarapu Sarath Chandra Reddy
7. Nishanth M
8. Pooja G V
9. Thirthan K
10. Harsh Chawla
11. Kunal K C
12. Akshit Dabash
13. Rohit Kumar Singh
14. Rahul Sahani B
15. Saurabh Shukla
16. Abishek S
17. Pavithra T R

We would like to thank our beloved Chancellor, **Dr. P. Shyama Raju** for providing all facilities and support to conduct this program., Registrar, **Dr M. Dhanamjaya** for his continuous support.

We also thank our Director, School of ME, **Dr. K S Narayanaswamy**, for his constant support and always motivating us to organize such events in School of ME.

**Coordinators:** **Majety Vineeth** (President & Head, The Inquisity Club)  
**G V Venkata Sandarsh** (Chief Advisor, The Inquisity Club)  
**Jubin Das** ( Social Media & Branding Head, The Inquisity Club)

**Faculty Advisors & Coordinators:** **Dr. Niranjana Hiremath**

*Hiremath 2/15/20*

*[Signature]*  
*2/15/20*

**Signature of the Director**  
Director  
School of Mechanical Engineering  
REVA University  
Rukmini Knowledge Park, Kattigenahalli  
Yelahanka, Bengaluru - 560 064

147



**REVA  
UNIVERSITY**

Established as per the section 2(f) of the UGC Act, 1956.  
Approved by AICTE, New Delhi



**THE INQUIS  
CLUB**

36

## **Webinar Report on Automobile Competitions and Recruitment in the Team**

**School: Mechanical Engineering**

**Venue: MS Teams (Online)**

**Date: 18/07/2020**

**Year: 2019-20**

**Presenter: Aryan Racing Team, REVA University..**

**E-Banner:**



**REVA  
UNIVERSITY**  
Bengaluru India



**I-GAUGE**  
INDIAN UNIVERSITY GRADUATE  
GOLD



---

**School of Mechanical Engineering**

**Organizes  
A Webinar on**

**“Automobile Competitions and Recruitment in the Team”**

**Aryan Racing Team, REVA University.**

**Date : 18<sup>th</sup> July, 2020**

**Venue : MS Teams**

**Time: 10.00 AM to 11.30 AM.**

[www.reva.edu.in](http://www.reva.edu.in)



Program schedule:

Topic	Date	Time
Automobile Competitions and Recruitment in the Team	18/07/2020	10.00 AM to 11.30 AM

Gallery:

The screenshot shows a Zoom meeting gallery with several participants. The participants are arranged in a grid, with some showing their video and others showing their initials in a circle. On the right side, there is a 'People' list with names and status indicators.

**Participants in Gallery:**

- Dr. Niranjan Hiremath
- DAVIUS CHIRAG
- SRI JUBIN DAS
- GS
- AKSHAY MAYARAJ
- GUJIPALLI VENKATA VENKATESH
- AG
- HS
- SM

**People List (Right Side):**

- Invite someone
- Presenters (9)
- MAHATMA VINIL III
- AKSHAY MAYARAJ
- OSTAN M
- DAVIUS CHIRAG
- Dr. Niranjan Hiremath (Speaker)
- GAUTHAM S
- GUJIPALLI VENKATA VENKATESH
- HARSHITH B R (Leaving...)
- SRI JUBIN DAS
- Attendees (17)
- ASHWINAND M (On hold)
- ARJUN S (Leaving...)
- ASHWIN ALEX GEORGE
- Dasaranga Santhosh Kumar (Guest)
- DEEPAK T B

**Bottom Bar:** 01:36:52, Microphone, Video, Screen Share, Chat, Help, End Meeting, Join Audio Meeting



### Electrical Department



1. Electrical Components used in Engine Powered ATV
  - Kill switches
  - 12V battery
  - Brake light
  - Brake switch
2. Innovations
  - DAQ SYSTEM(Data Acquisition System)
  - DRIVER HEALTH CONDITION-Heart rate and pulse rate sensors
3. Sensors Used
  - Hall Effect Sensor
  - TRANSMISSION TEMPERATURE SENSOR
  - IMU(Inertial Measurement Unit)



### EV Vehicle



- Motor 3kW , 3000RPM, 48V, BLDC Motor ,10 7N-m
- Torque: 70 Nm
- Controller: Kelly KLS7245M, 100Amp/200Amp(30 sec)
- Fuse: 120Amp,48 V
- Battery : 48V, 110Ah ,5.28kWh
- Gear Ratio: 7:1
- Tire Size: 25 inch
- Gear Box Coupled using Universal coupling
- Acceleration: 1.39 m/s<sup>2</sup>

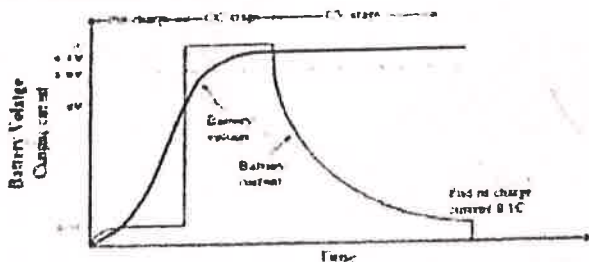
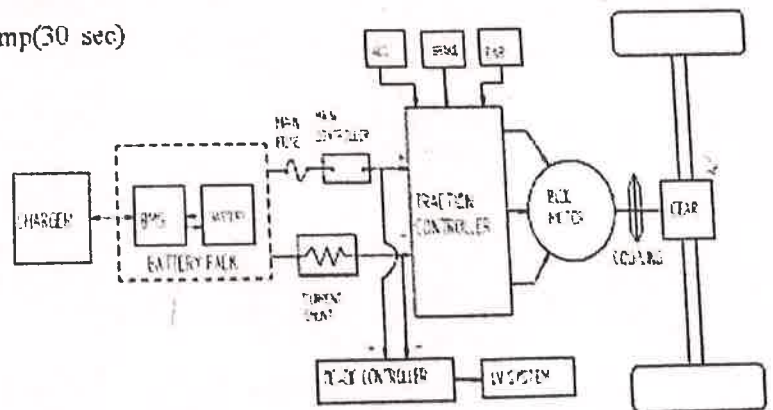

Fig. Transmission for Electric Vehicle



# Brakes

- Hydraulic braking system
- 4 Disc brakes Dual Master Cylinder.
- Diagonal split or X split braking system
- Outboard brake assembly



Brake Calculations	Results
Weight transfer at 40 kmph to 0 kmph	Front - 2589.4 N Rear - 953.58N
Braking force	Front - 1294.92 N Rear - 479.79 N
Brake torque per wheel	Front - 410.98Nm Rear - 56.13Nm
Pressure on master cylinder	$1.88 \times 10^7 \text{ N/m}^2$
Force on calliper cylinders	3322.84 N
Force on disc	3322.84 N

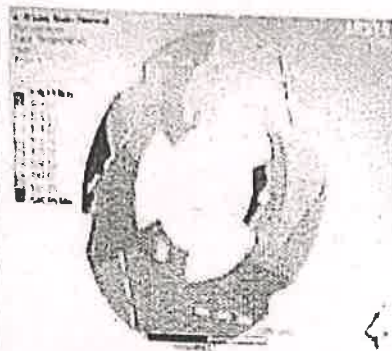

DISC THERMAL ANALYSIS

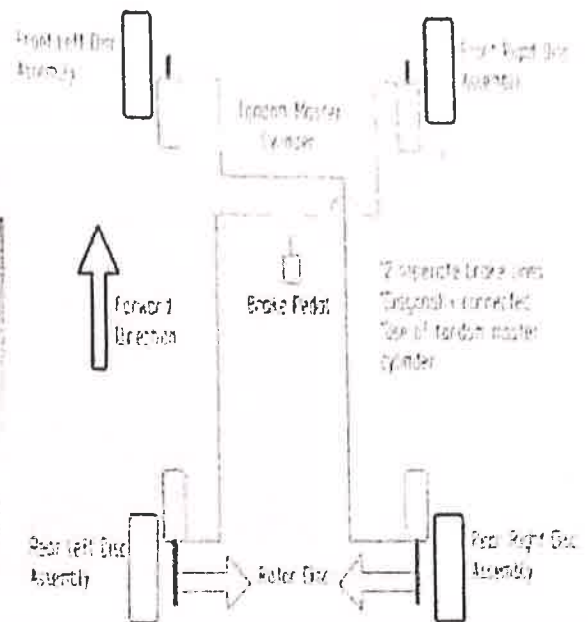

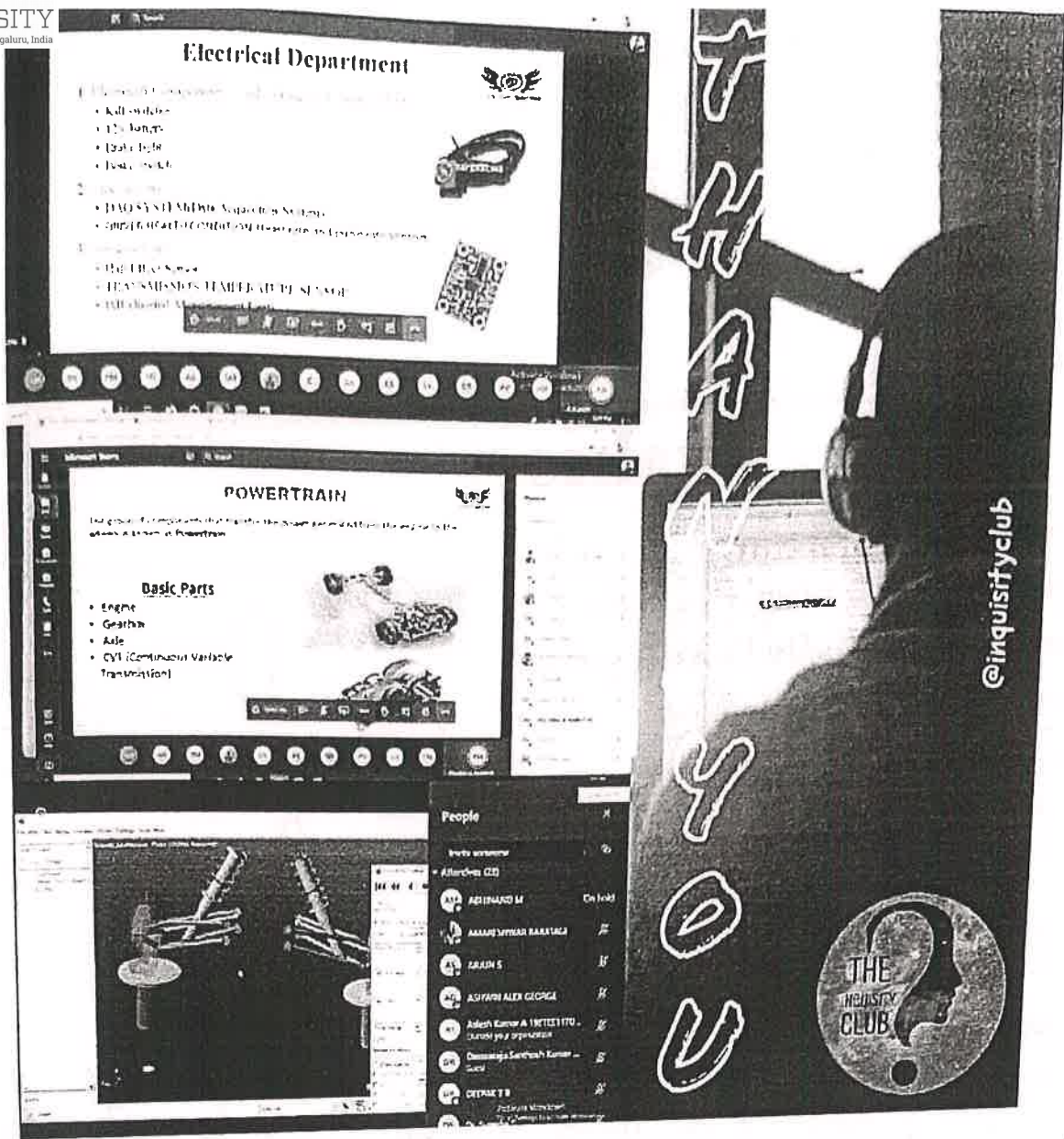

**Attendees:**

1. Arjun
2. Dhanvi
3. Jubin
4. Raghunanda
5. Manoj
6. Sathivika
7. V Anita
8. Vinod R
9. Thirthan K
10. Harsh Chawla



11. Kunal K C
12. Akshit Dabash
13. Rohit Kumar Singh
14. Rahul Sahani B
15. Saurabh Shukla
16. Abishek S
17. Venkata Sandarsh

We would like to thank our beloved Chancellor, **Dr. P. Shyama Raju** for providing all facilities and support to conduct this program., Registrar, **Dr M. Dhanamjaya** for his continuous support.

We also thank our Director, School of ME, **Dr. K S Narayanaswamy**, for his constant support and always motivating us to organize such events in School of ME.

**Coordinators:** **Majety Vineeth (President & Head, The Inquisity Club)**  
**G V Venkata Sandarsh (Chief Advisor, The Inquisity Club)**  
**Jubin Das ( Social Media & Branding Head, The Inquisity Club)**

**Faculty Advisors & Coordinators:** **Dr. Niranjana Hiremath**

*18/7/20*

*[Signature]*  
**Signature of the Director**  
**Director**  
**School of Mechanical Engineering**  
**REVA University**  
**Rukmini Knowledge Park, Kattigenahalli**  
**Yelahanka, Bengaluru - 560 064**



**Report on Community Outreach Program at Bangalore rural area,  
Devanahalli Taluk.**

**School of Architecture, REVA University**

**26/02/2021**

Faculty coordinator: **Asst. Prof Dr. Anupama R M, Asst .Prof. Nagaraja S**

Course: **Community outreach program**

Place of Activity conducted: **GOVERNMENT HIGH SCHOOL JALIGE**

Students: **1<sup>st</sup> Semester B.Arch.**

No of Students: **30**

We are glad to inform you that School of Architecture, REVA University has adopted GOVERNMENT HIGH SCHOOL JALIGE. As part of the adoption drive, we have planned an activity at our adopted school JALIGE on 26/02/2021 that is on Friday and below is the brief of the activity.

Students of first semester, School of Architecture, REVA University as part of Basic Design and Visual Arts studio are to carry out a video exercise involving the eight prominent principles of design, namely Balance, Proportion & scale, Rhythm, Emphasis, Harmony, Unity, Variety and Contrast. They are to illustrate these principles in the form of video presentation in collaboration with students from Jalige school as part of Abhivruddhi initiative. This activity would help our students bond with the students at Jalige and could go a long way in establishing a peer bond amongst them.

Our students will demonstrate the skills of videography and making of video montages using cell phones. This will also help us identify students who have a knack for learning videography and film making in the process. The activity will not only help them learn a new



skill, but also focus on one of the many virtues of technology against the cons. This exercise will also strengthen the mentorship initiative to be taken up by our first semester students. As a part of Mathematic learning activity our students guided the kids in making the 3D model of the Geometrical shapes such as Triangle, Cube, Rectangle, Cylinder, Pentagon etc.

REVA students, were also a part of clean drive program conducted from the GRAMA PANCHAYAT to create an awareness about cleanliness of the environment and surroundings by performing STREET PLAY and SINGING by our students in the streets of the village.

And also to enrich, spread and uplift our Indian culture we made an attempt of teaching CLASSICAL MUSIC as a part of academic learning for the students.

Students were very excited and benefited by all the activities conducted.

Students from 1st standard to 7th standard were part of this activity with the support of our 1st semester students. The students experienced the pleasure of teaching and making the exercise interesting for kids.

A total of 20 students from 1st to 7th standard were part of this program.

A total of 30 students from 1st semester B.Arch. participated in the community outreach program and they were accompanied by 4 faculty Dr.Anupama. R M, Er. Nagaraja S, Ar. Divya Hemantha Raj, Ar. Mahima Jadadeesh.

I would like to thank our Director in charge Prof. Vidya Srikanth for her immense support.

I would like to extend our thanks to Dr. Kiran Kumari on behalf of UIIC department for their immense support.

I sincerely thank Management, REVA University for this initiative that helps bring our students closer to society.



REVA  
UNIVERSITY

Bengaluru, India

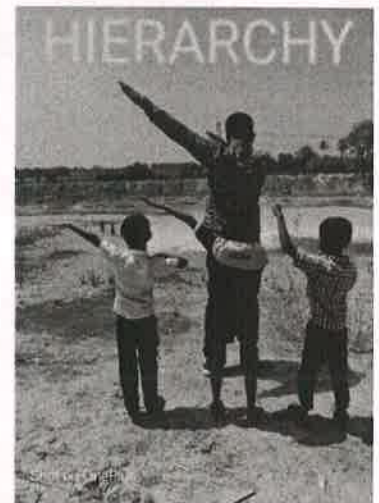



REVA  
UNIVERSITY

Bengaluru, India

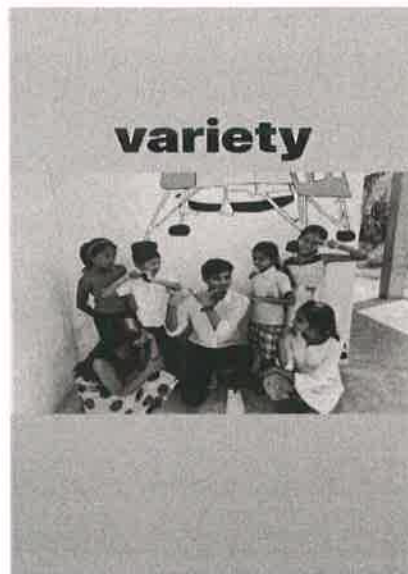

*Vijaya Subramani*  
01/03/21



**Report on Community Outreach Program at Bangalore rural area,  
Devanahalli Taluk.**

**School of Architecture, REVA University**

**29/03/2021**

Faculty coordinator: **Asst. Prof Dr. Anupama R M, Asst .Prof. Nagaraja S**

Course: **Community outreach program**

Place of Activity conducted: **GOVERNMENT HIGH SCHOOL JALIGE**

**Students: 4<sup>th</sup> Semester B.Arch.**

No of Students: **20**

No of JALIGE students: 15

We are glad to inform you that School of Architecture, REVA University has adopted GOVERNMENT HIGH SCHOOL JALIGE. As part of the adoption drive, we have planned an activity at our adopted school JALIGE on 29/03/2021 that is on Monday and below is the brief of the activity.

Students of Fourth semester, School of Architecture, REVA University as part of learning we conducted 3 activities in JALIGE school.

CLAY MODELING - Gave a lecture on Importance of Natural clay and our students demonstrate the skills of making 3D modeling out of natural clay to make them understand the material. The students enjoyed the making of model and came up with creative models at the end.

YOGA - Explained and gave a lecture on importance of physical exercise to our body by yoga the health benefits, mental health and stability by yoga.

Our faculty & students demonstrate the yoga to all the students and made them do the basics of yoga, stretches and Surya Namskara.



Our 4<sup>th</sup> semester students distributed Books and Pens to all the 15 kids to motivate them to be Educated

Students were very excited and benefited by all the activities conducted.

Students from 5<sup>th</sup> standard to 7<sup>th</sup> standard were part of this activity with the support of our 4<sup>th</sup> semester students. The students experienced the pleasure of teaching and making the exercise interesting for kids.

A total of 15 students from 1<sup>st</sup> to 7<sup>th</sup> standard were part of this program.

A total of 20 students from 4<sup>th</sup> semester B.Arch. participated in the community outreach program and they were accompanied by 2 faculty Dr. Anupama. R M, Er. Nagaraja S

I would like to thank our Director in charge Prof. Vidya Srikanth for her immense support.

I would like to extend our thanks to Dr. Kiran Kumari on behalf of UIIC department for their immense support.

I sincerely thank Management, REVA University for this initiative that helps bring our students closer to society.





REVA  
UNIVERSITY

Bengaluru, India





REVA  
UNIVERSITY

Bengaluru, India







REVA  
UNIVERSITY

Bengaluru, India



Vedya Sri K...  
04/04/21



186

39



**REVA**  
**UNIVERSITY**

Bengaluru, India

**SCHOOL OF ELECTRICAL AND ELECTRONICS  
ENGINEERING**

# **ABHIVRIDDI**

**A REPORT OF POST COVID-19 AWARENESS PROGRAM  
CONDUCTED ON 18-12-2020**

**AT**

**GOVERNAMENT LOWER PRIMARY SCHOOL,  
BANDIKODIGEHALI PALYA.**



This Photo by Unknown Author is licensed under CC BY-SA

School of Electrical and Electronics Engineering, REVA UNIVERSITY adopted a Government Lower Primary School, Bandikodigehalli Playa, and Bengaluru north taluk under Government school adoption program (ABHIVRIDDI).

As a part of ABHIVRIDDI phase -1, school of EEE conducted a program based on post COVID-19 awareness to school children, teachers, and parents. On Friday 18<sup>th</sup> Dec-2020.



About 50 residents participated in the program. Sanitizer, face masks and chocolates were distributed to all participants.

An activity is conducted among all participants to create awareness and precautions to be taken to control the spread of virus.

This is an initiative of REVA UNIVERSITY to improve the needs of the adopted government school by conducting different programs to promote education at government schools. The program was witnessed by the parents and some other residents of the village.

There was a good interaction between team REVA and participants to fight against COVID-19.

Parents and children participated with great enthusiasm in program to promote control and prevention of COVID-19.



**REVA**  
**UNIVERSITY**

Bengaluru, India

We thank our management for taking a great initiative to promote education at government schools by helping the needy community. We also thank UIIC, REVA UNIVERSITY for guiding us in successfully conducting the meaningful event.

Some of the snaps took during the event.



*Dee*  
Director

School of Electrical &  
Electronics Engineering  
REVA University, Rukmini Knowledge Park  
Kattigenahalli, Yelahanka, Bengaluru-560 08



**REVA**  
**UNIVERSITY**  
Bengaluru, India

**SCHOOL OF ELECTRICAL AND ELECTRONICS  
ENGINEERING**

# **ABHIVRIDDI**

**A REPORT OF EVENTS CONDUCTED AS A PART OF  
FOUNDER'S DAY CELEBRATION ON 06-01-2021**

**AT**

**GOVERNAMENT LOWER PRIMARY SCHOOL,  
BANDIKODIGEHALLI PALYA.**





School of Electrical and Electronics Engineering, REVA UNIVERSITY adopted a Government Lower Primary School, Bandikodigehalli Playa, Bengaluru north taluk under Government school adoption program (ABHIVRIDDI).

As a part of Founder's Day-2021, school of EEE conducted a few competitions for the school children on 04-01-2021. The competitions conducted were drawing and dancing. All children participated with great enthusiasm. They are provided with drawing materials like, drawing sheets, pencils, color crayons, erasers.

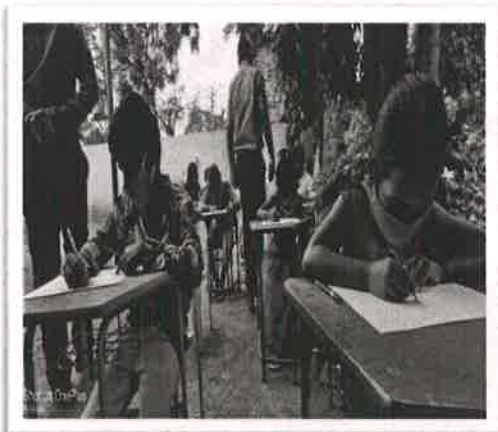

Kids shown a great interest in participation, drawn a very good drawing. Finally, among all, three best performers were selected as winners.

The next competition conducted was dancing, some kids participated and won the prizes.



Refreshments were distributed to all participants.

This is an initiative of REVA UNIVERSITY to improve the needs of the adopted government school by conducting different programs to promote education at government schools. The program was witnessed by the parents and some other residents of the village.



Founder's Day celebration on 06-01-2021.

On sixth Jan-2021, all members of EEE visited the adopted school to celebrate REVA FOUNDER'S DAY-2021.

Director School of EEE, Dr. Rajashekar P Mandi, Dean Research, and Innovation Council Dr. B P Divakar accompanied the team EEE. A birthday cake was cut to mark the celebration of REVA Founder's Day.



Prizes were distributed to all the winners. All participants are distributed with the gifts. Special gifts were distributed to the teachers.



REVA  
UNIVERSITY

Bengaluru, India







We thank our management for taking a great initiative to promote education at government schools by helping the needy community. We also thank UIIC, REVA UNIVERSITY for guiding us, in successfully conducting the meaningful program.



  
Director  
School of Electrical &  
Electronics Engineering  
REVA University, Rukmini Knowledge Park  
Kattigenahalli, Yelahanka, Bengaluru-560 06



**REVA**  
**UNIVERSITY**

Bengaluru, India

**SCHOOL OF ELECTRICAL AND ELECTRONICS  
ENGINEERING**

# **ABHIVRIDDI**

**A REPORT OF 'SWACHH CAMPUS' PROGRAM  
CONDUCTED ON 22-02-2021**

**AT**

**GOVERNAMENT LOWER PRIMARY SCHOOL,  
BANDIKODIGEHALI PALYA.**



This Photo by Unknown Author is licensed under CC BY-SA

School of Electrical and Electronics Engineering, REVA UNIVERSITY adopted a Government Lower Primary School, Bandikodigehalli Playa, Bengaluru north taluk under Government school adoption program (ABHIVRIDDHI).

As a part of ABHIVRIDDHI, School of Electrical & Electronics Engineering conducted a 'SWACH CAMPUS' program on Monday 22<sup>nd</sup> Feb-2021, about twenty students, six staff members, teachers and school children participated in the program.

With all safety measures complete campus was cleaned by removing weed, debris spread across the campus to ensure the clean campus.



*Pictures before the activity.*





REVA  
UNIVERSITY

Bengaluru, India

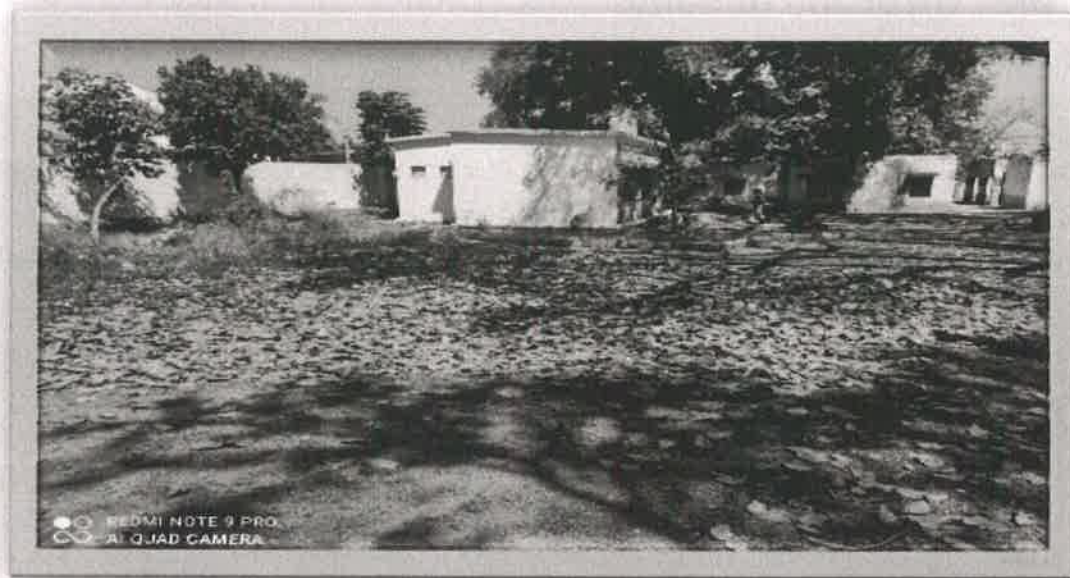



*Pictures after the activity.*



This is an initiative of REVA UNIVERSITY to improve the needs of the adopted government school by conducting different programs to promote education at government schools.

Students, staff, teachers, and children participated with great enthusiasm.

We thank our management for taking a great initiative to promote education at government schools by helping the needy community. We also thank UIIC, REVA UNIVERSITY for guiding us in successfully conducting the much-needed activity.

*Some of the snaps took during the event.*







REVA  
UNIVERSITY

Bengaluru, India

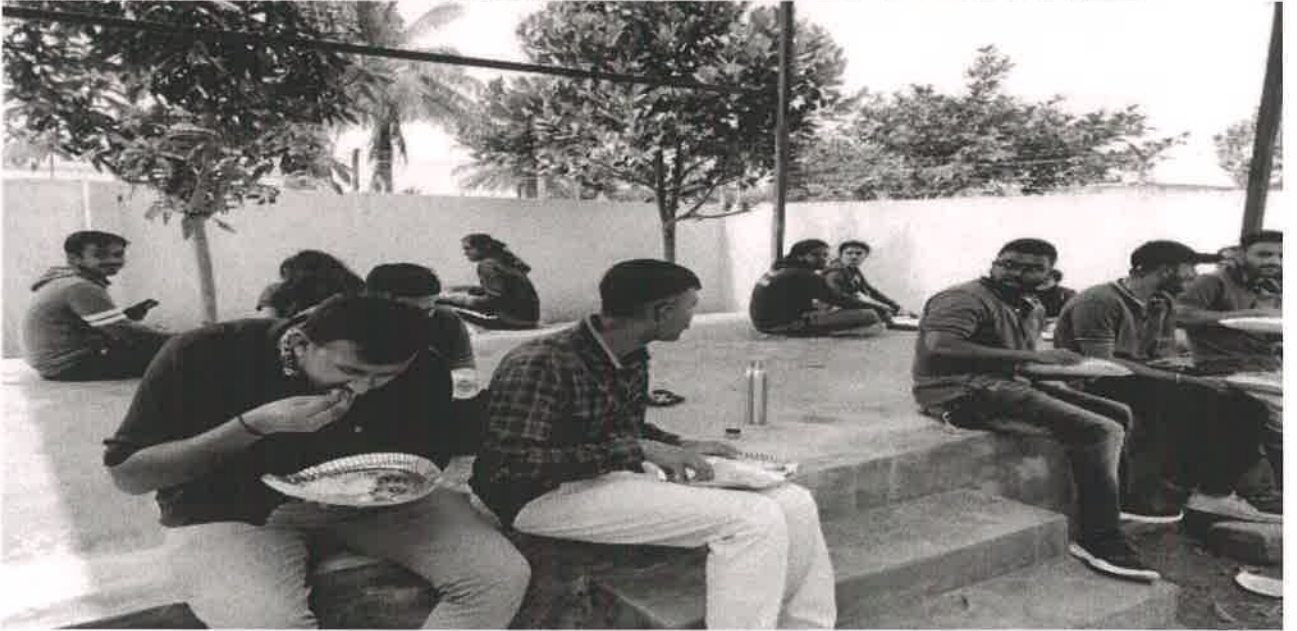



**REVA**  
**UNIVERSITY**

Bengaluru, India



Director

School of Electrical &  
Electronics Engineering  
REVA University, Rukmini Knowledge Park  
Kattigenahalli, Yelahanka, Bengaluru-560 08





## **REVAABHIVRIDDI**

**Government Higher Primary School  
Kattigenahalli, Yelahanka, Bengaluru**

**Adopted by,**

**SCHOOL OF ECE, REVA UNIVERSITY**

**Event:**

- 1) Founder's day celebration
- 2) Cake cutting and distribution of sweets
- 3) Prize distribution

**Date:**6<sup>th</sup> January 2021

REVA University has always played a major role in promoting education, health and hygiene. The University has been conducting and hosting awareness activities. REVA Abhivriddi is an initiative from REVA University to donate, to change, to educate and to empower those underprivileged children in adopted schools.

On account of REVAAbhivriddi, The School of Electronics and Communication Engineering, REVA University celebrated Founder's day and distributed prizes,sweets and also organized awareness programme about COVID 19 forthe students of adoptedGovernment Higher Primary School, Kattigenahallion 6<sup>th</sup> January 2021.

Dr. R C Biradar, Professor & Director - School of Electronics and Communication Engineering, spoke about the achievements of the Chancellor sir and the purpose of Founder's day celebration. He advised the students to maintain cleanliness and educate others to face the pandemics situation.

Dr.Sudarshan K M Asst. Director School of Electronics and communication Engineering, addressed the Govt school students about the precautions to be taken during pandemic and also gave them beneficiary tips on health. He also mentioned Importance of digitalized education in rural sector.

Co-ordinators, faculties, UIIC staff and Students of School of ECE organized Founder's day celebration and distributed prizes for the winners of the conducted sports activities and also distributed sweets to all the students and teachers.

The program was witnessed by the Director, Assistant Director, faculties and students of School of ECE and also witnessed by staff of UIIC team.The students were excited to receive prizes for the winning competitions and students expressed their gratitude and conveyed birthday wishes to Dr. P. Shyama Raju sir, Chancellor - REVA University.









**REVA**  
**UNIVERSITY**

Bengaluru, India



**Director**  
**School of Electronics &**  
**Communication Engineering**  
REVA University, Rukmini Knowledge Park  
Kattigenahalli, Yelahanka, Bengaluru - 560 064

**School of Electronics and Communication Engineering**

**Abhivridhi Program Report on  
"Cancer Prevention Awareness Program"**

**School/Department: School of Electronics and Communication Engineering**

**Venue:** Govt higher Primary School Kattigenahalli

**Date:** 4<sup>th</sup> February

**Year:** 2021

**Description of Event:**

The School of ECE Abhivridhi Team & ECE - NSS unit, REVA University had organized "**Cancer Prevention Awareness Program** ". for the students and staff of kattigenahalli Govt. Higher Primary school, on 4th February, 2021 from 1:00 pm to 2.30 pm . Around 110 staff and students participated in this event.

Cancer is the second leading cause of death globally. Youth are mostly into practicing unhealthy lifestyles, and cancer is a lifestyle disease, so the main focus is to work on it. The program focuses on healthy lifestyle, immunity, and cancer prevention.

We would like to thank our beloved Chancellor, Dr. P. Shyama Raju sir for providing all facilities and support to conduct this program. We also thank Pro Vice Chancellor Dr. M. Dhanamjaya sir, Registrar I/C Dr. N. Ramesh sir, Director of school of ECE Dr. R C. Biradar for their motivation and support in making this event a grand success.

**Abhivridhi coordinators:**

Prof. Subhash B K  
Dr. Ravi kumar M G

**ECE NSS UNIT coordinator:**

Prof. K Durga Prasad

**Highlights of Event:**

- 1) Basic steps of cancer.
- 2) Types of cancer prediction
- 3) Stages of cancer
- 4) How to prevent cancer
- 5) Healthy life style

Photographs of the event are attached for the Reference.

Photos:







**Director**  
**School of Electronics &**  
**Communication Engineering**  
REVA University, Rukmini Knowledge Park  
Kattienahalli, Yelahanka, Bengaluru - 560 064



**REVAAbhivridhhi**  
**Government Higher Primary School**  
**Kattigenahalli, Bengaluru**

**Event:**Computer Literacy Programs for 6<sup>th</sup> and 7<sup>th</sup> standard students

**Date:** 13 Mar 2021

**OrganisingMembers:** Dr. Manjunath Kounte, Dr. Nayana D K, Dr. Veena K N, Dr. Prabhat Kumar Panda, Prof. Md Tauseef, Prof, Madan H T, Dr. R Venkata Shiva Reddy, Dr. M Devanthan, Prof. Nirmal Kumar Benni, Prof. Sowmya C H, Prof. Sowmiya B B, Prof. Satyaprakesh B P, Prof. Subhash, Dr. Ravi Kumar M G, Mr. Nandan, Mr. Naveen, Mr. Bharath, Mr. Sunil, Mr. Kumar.

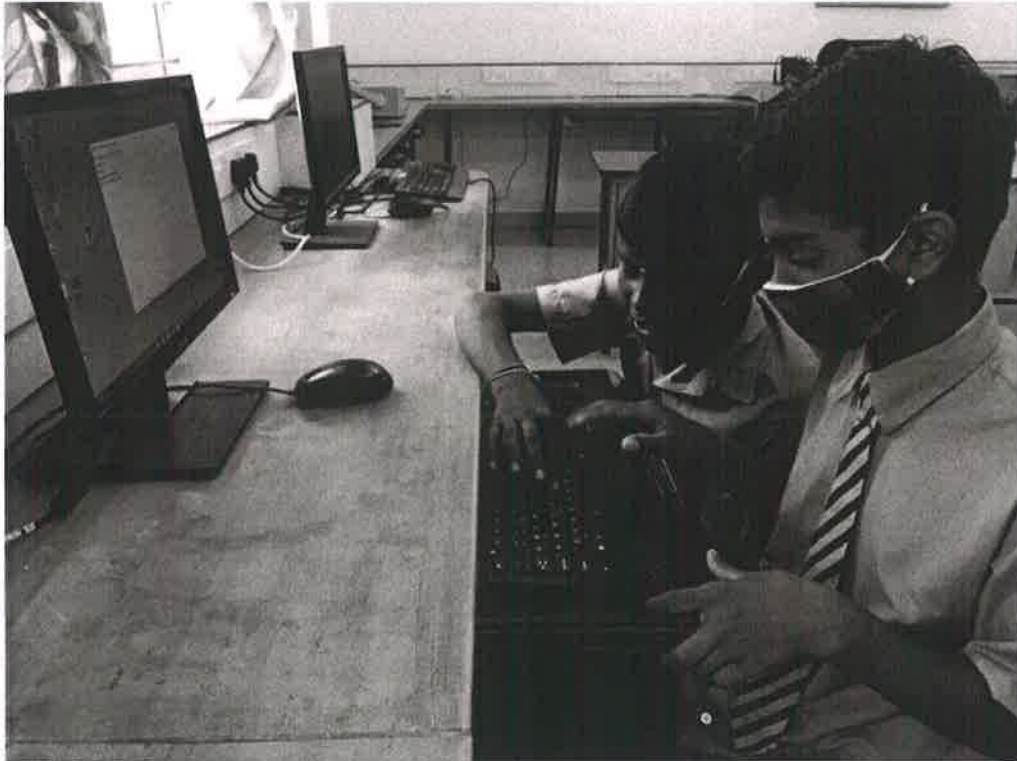

REVA Abhivridhhi is an initiative from REVA University to educate and empower those underprivileged children in adopted schools.



School of Mechanical Engineering  
Organized

“Aeronautical Society of India (AcSI) Student Chapter”

School: Mechanical Engineering

Venue: Online

Date: 03<sup>rd</sup> July 2020

Academic Year: 2020-2021

Recording Link: <https://web.microsoftstream.com/video/00811a5b-1f8a-4538-9b59-f5ffa5d27e7e>

Description of Event:

**Aeronautical Society of India (AcSI) FOUNDED on November 17, 1948**, Pandit Jawaharlal Nehru, the First Prime Minister of independent India becomes the First Chief Patron of the Society.

The School of Mechanical Engineering had organized inaugural ceremony of Aeronautical Society of India (AcSI) student chapter for students of Mechanical Engineering, REVA University on Friday, 3 July, 2020 between 01.30 AM to 01.00 PM. The Chief Guest for the inaugural ceremony of AcSI student chapter was **Commodore C.D. Balaji (Retd)**, Distinguished Scientist, Chairman, K-Tech Centre of Excellence in Aerospace & Defence, GoK, Former Director, Aeronautical Development Agency (ADA).

Outstanding Scientist, Former Director of the Aeronautical Development Agency (ADA) and Programme Director of the Light Combat Aircraft (LCA).

Comde Balaji holds a BE in Mechanical Engineering and a Masters degree in Aerospace Engineering from the Indian Institute of Science, Bengaluru. Commissioned into the Indian Navy's engineering branch in September 1978, Comde Balaji has specialised in the Naval Aviation Arm. He has served as Air Engineer Officer of INAS 310 (Alize aircraft) for about 3 years embarking the Aircraft Carrier Vikrant.

He joined ADA on deputation in 2002 to work on the development of a naval version of the light fighter. In December 2006, he left the Navy and fully moved to ADA.

The guest of honor for program was, **Mr. P.Mucen Ahamadulla Khan**, Test Engineer of Transmission Assemblies of Helicopters at Rotary Wing Research and Design Center, HAL and Hon. Secretary – Bangalore Branch, Aeronautical Society of India

- To promote the advancement and dissemination of knowledge of Aeronautical Sciences / Technologies.
- To strive for the elevation of Aeronautical and Aerospace Profession.
- To provide greater awareness to the students in the Aeronautical sciences and Technologies by conducting the programs such as conferences, workshops, guest lecture, internships, industrial visits and skill development.

### **Benefits of the Chapter**

- The Society provides platform to the members to **meet and discuss issues of mutual interests with professionals in the field of Aeronautics and Aerospace Sciences.**
- The Society provides free participation in the **seminars, Workshops, and conferences organized by the Society to promote aeronautics and aerospace sciences** and to bring about greater awareness in these fields.
- The Society **publishes a quarterly journal devoted to research and technical papers** on various facets of aeronautical sciences. Every member is entitled for a copy of the journal.
- The Society **publish newsletter/ bulletin every month and distribute free of cost to its member.** The Society confers numbers of awards every year to its members for outstanding contribution in fundamental and applied research in the field of aeronautics and aerospace.
- The Society **conducts annual essay competitions to recognize and encourage talent amongst its young scientist/engineer/ students members.**
- The Society **provides library facilities at HQ at Delhi and member of its Branches.**
- The Society **provides financial assistance as well as organizes on job training** for deserving student members. Concessional subscription rates for participation in Seminars/Workshops organized by allied Institutions.

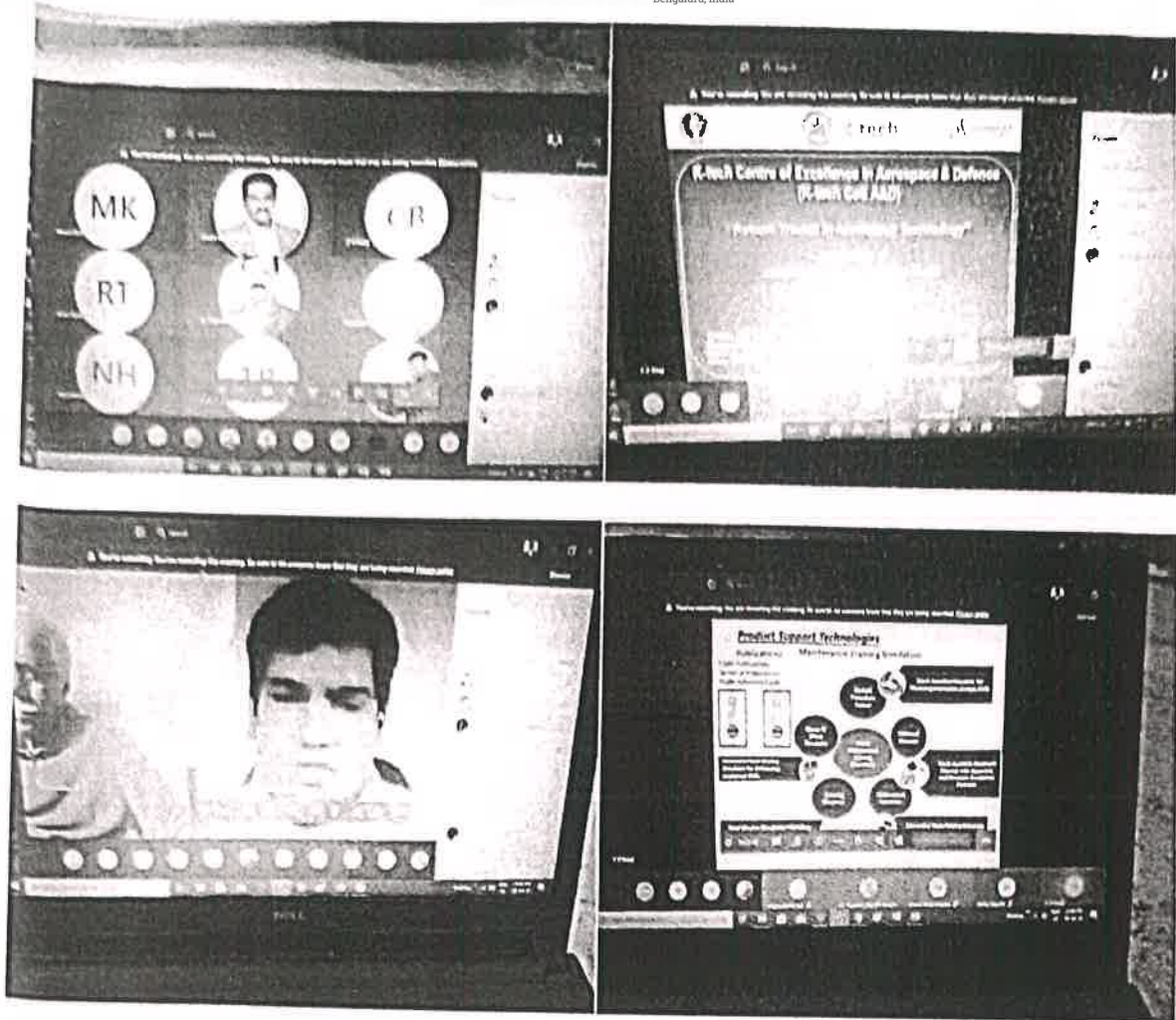

I express my sincere gratitude to our Honorable Chancellor **Dr. P. Shyama Raju Sir**, for encouraging and providing facilities at REVA University.

I thank our Honorable Vice Chancellor **Dr. Shankapal Sir**, for his continuous support to organize the event.

I thank our Director **K.S. Narayanaswamy Sir**, for his immense support and motivation to organize the event.

I thank **Dr. Raju B.S Sir** and all the faculty members of School of Mechanical Engineering for their continuous support.

**Coordinator:**

**Dr. Shanawaz Patil**

*Patil 4/7/2020*



*[Signature]* 4/7/20

**Director/School of ME**  
Director  
School of Mechanical Engineering  
REVA University  
Rukmini Knowledge Park, Kattigenahalli  
Yelahanka, Bengaluru - 560 064





Bangalore Branch

49



## **School of Mechanical Engineering**

### **Report on**

### **Webinar on “Advanced Materials for Aerospace Application”**

**School:** Mechanical Engineering

**Venue:** M.S.Teams (Online)

**Date:** 19/07/2020 at 04:00 PM

**Year:** 2020-21

#### **Description of the Event:**

The School of Mechanical Engineering in Association with Aeronautical Society of India (AeSI) Bengaluru., organized a Webinar on “**Advanced Materials for Aerospace Application**” on 04.09.2020 from 04:00 PM to 05.30 PM for members of AeSI B.Tech. Mechanical Engineering students. The resource person identified was Mr. Madeva Nagaral, Deputy Manager (Design) Aircraft Research & Design Centre, HAL-Bengaluru. Around 75 students and faculty members got benefited from the webinar.

#### **About the Webinar:**

The webinar aimed at giving overview on features of Advanced materials for used in aerospace applications. The chief guest covered the topics on “Composite Materials, Classification of composite materials, Metal Matrix Composites, Polymer matrix composites and other alloys used in aerospace sectors. Graphene-integrated composites are constructed by introducing thin graphene



Bangalore Branch



REVA  
UNIVERSITY

Bengaluru, India

sheets, a few billionths of a meter thick, into hierarchical fiber composites as a nano-additive that improves the material's mechanical properties.

"Graphene's high aspect ratio, high flexibility and mechanical strength enable it to enhance the strength of weak points in these composites, such as at the interface between two different components," explains Palermo. "Its tunable surface chemistry also means that interactions with the carbon fiber and polymer matrix can be adjusted as needed."

### **About the Resource Person:**

Mr. Madeva Nagaral is working as a Deputy Manager in Configuration and Mass Properties Group, Aircraft Research and Design Centre (ARDC), Hindustan Aeronautics Limited (HAL), Bangalore since Jan 2012. He has done his BE and M.Tech from Basaveshwar Engineering College, Bagalkot. Honored with Honorary Doctorate in the field of Science and Technology by International Virtual Peace University, Chennai. Presently he is pursuing his Ph.D in Siddaganga Institute of Technology, Tumkur. Previously, he worked as an Assistant Professor in the Department of Mechanical Engineering, MVJ College of Engineering, Bangalore, for the period of three years (2009-2011). Also, has worked as an Engineer in Bharat Electronics Limited, for the period of one year.

He is the recipient of State Award (2014) by Karnataka Government and Jagajyothi Shri Basaveshwar Kayakashree (2015) and Karnataka Bhushana (2015) and Sir M Visvesvaraya (2016) award by Karnataka Sanskrutik Academy, Bangalore, Basav Ratna (2016) from Basav committee Bijapur for his outstanding contribution in the field of Science and Technology. Chosen for IIFS most coveted 'Bharat Jyoti' award and also chosen for 'The Best Inspiration Leadership Award' by Top Engineers Association, Chennai and received by Chief Minister of Pondichery on 26th March 2017, IRSD Outstanding Researcher Award-2017. He has also received Best Faculty Award for the year 2010 at MVJ College of Engineering, Bangalore. He is the recipient of Engineer of the year-2019 Award by the International Association of Research and Developed Organization, Goa on 18th August 2019.

Since 2012, his 127 research papers have been published in National and International Journals and he has presented more than 102 research papers in national and international



Bengaluru Branch



**REVA**  
**UNIVERSITY**

Bengaluru, India

conferences organized at various engineering colleges all over the country. His research papers are having more than 525 Google Scholar Citations. He guided more than 48 UG and 32 PG projects. 45 international journal papers were reviewed, as a reviewer.

28 guest talks were delivered as a key note resource speaker in various engineering colleges of India. He has chaired as a Guest and Session Judge for National and International Conferences held at various Engineering Colleges.

### Webinar Link:

<https://teams.microsoft.com/join/19%3a1e200373e41c4f65b9ac26d02c6503a0%40thread.tacv2/1594708355392?context=%7b%22id%22%3a%22474565c1-bca4-4295-a2f5-b0c7dbf2591c%22%2c%22oid%22%3a%22777a7e13-44c0-4fe1-9e91-c076992c7307%22%7d>

### Gallery:



REVA UNIVERSITY  
Bengaluru, India  
Established as per the section 3(1) of the UGC Act, 1956  
Approved by AICTE, COA and BCI, New Delhi



**School of Mechanical Engineering**  
Organises Webinar on  
**Advanced Materials for Aerospace Applications**  
Resource person



**Dr. Madeva Nagara, M.Tech (Ph.D)**  
Deputy Manager (Design)  
Aircraft Research & Design Centre  
Hindustan Aeronautics Limited Bengaluru - 560 037

Date: 19<sup>th</sup> July, 2020  
Time: 11:30 A. M. to 1:00 P. M.      Webinar link: <https://bit.ly/20tLTtc>      [www.reva.edu.in](http://www.reva.edu.in)



Bangalore Branch



**REVA**  
**UNIVERSITY**

Bengaluru, India

We would like to thank our beloved Chancellor, **Dr. P. Shyama Raju** for providing all facilities and support to conduct this program. Also, we thank **Vice Chancellor and Registrar of REVA University** for their continuous support.

We also thank our Director, School of ME, **Dr. K S Narayanaswamy** and **Asst Director, Dr. Mahesh L.** for their constant support and always motivating us to organize such events in School of ME.

We also thank **Dr. Raju B. S** Sir for his continuous support and guidance to organize such webinars.

We also thank all the faculty members of our school and Students for their active participation

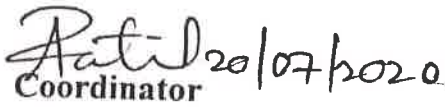
  
Coordinator

**Dr. Shanawaz Patil**

  
Director

**Dr. K.S. Narayanaswamy**

Director  
School of Mechanical Engineering  
REVA University  
Rukmini Knowledge Park, Katlu Mahalli  
Yelahanka, Bengaluru - 560 064





**School of Mechanical Engineering**

**Report on**

**Webinar on “Product Development and Productionization”**

**School:** Mechanical Engineering

**Venue:** M.S.Teams (Online)

**Date:** 04/09/2020 at 04:00 PM

**Year:** 2020-21

**Description of the Event:**

The School of Mechanical Engineering in Association with Aeronautical Society of India (AeSI) Bengaluru., organized a Webinar on **“Product Development and Productionization”** on 04.09.2020 from 04:00 PM to 05.30 PM for members of AeSI B.Tech. Mechanical Engineering students. The resource person identified was **Wg CDR(Retd) Simon. K. John, Emeritus Scientist ( Sc G)**. Around 80 students and faculty members got benefited from the webinar.

**About the Webinar:**

The webinar aimed at giving overview on features of Product Development. He covered the topics on **“Product life Cycle, PLC Stages, Design and Development Stages, Product Design and realization, Technology transfer, Product Specification etc.**

**About the Resource Person:**

**Wg CDR(Retd) Simon. K. John, Emeritus Scientist ( Sc G).**



Bangalore Branch



**REVA**  
**UNIVERSITY**

Bengaluru, India

**Wg Cdr (Retd) Simon. K. John** has served Indian Air Force for more than 23 yrs before joining CEMILAC DRDO as a Senior Scientist in 2006. During his tenure in Air Force, he held various vital appointments like Senior Engineering Officers of Helicopter Operating units, Chief Engineering Officer of an Operational Air Base, Chief of Quality Assurance & Production of an Aircraft Production Base, Deputy Director at Air HQR's in H/C Directorate, Chief Instructor of an Airman Technical Training Institute, Commanding Officer of a Promotion Exam Board and Senior Technical Instructor of Aeronautical Engineering ab-initio courses and Department Head of Mgt Faculty at Air Force Technical College at Bangalore. To his credit he was associated with the famous Operation Meghdooth involving occupation of Siachen Glacier in 1984-85 and co-ordinating the UN mission to Sierra Lone in 1999-00 and Kargil Operations in 1999 from IAF HQR's New Delhi.

Wg Cdr Simon, is an Alumnus of the prestigious Indian Institute of Science Bangalore with ME in Aerospace Engineering besides an MBA degree in Operation Mgt from IGNOU New Delhi. Further he has been a visiting Guest Speaker/adjunct faculty for various Engineering Institutes around the country during these days. Soon he will be honored with Doctor of Philosophy in Organizational Performance Enhancement Methodology studies in Operational Management domain from Visvesvaraya Technological University (VTU) Belgaum. To his credit, he has published/ presented more than 25 Scientific cum Management Papers in various National and International forums along with a Copy Right besides co-authoring of two recent books namely Helicopter Technology and Elements of Aerodynamics, which are presently in circulation for VTU students.

### **Webinar Link:**

<https://teams.microsoft.com/l/meetup-join/19%3a13e9c2f5c94d4bb6a00f4c3c0b84d67d%40thread.tacv2/1598850225403?context=%7b%22Tid%22%3a%22474565c1-bca4-4295-a2f5-b0c7dbf2591c%22%2c%22Oid%22%3a%22777a7e13-44c0-4fe1-9e91-e076992c7307%22%7d>

### **Gallery:**



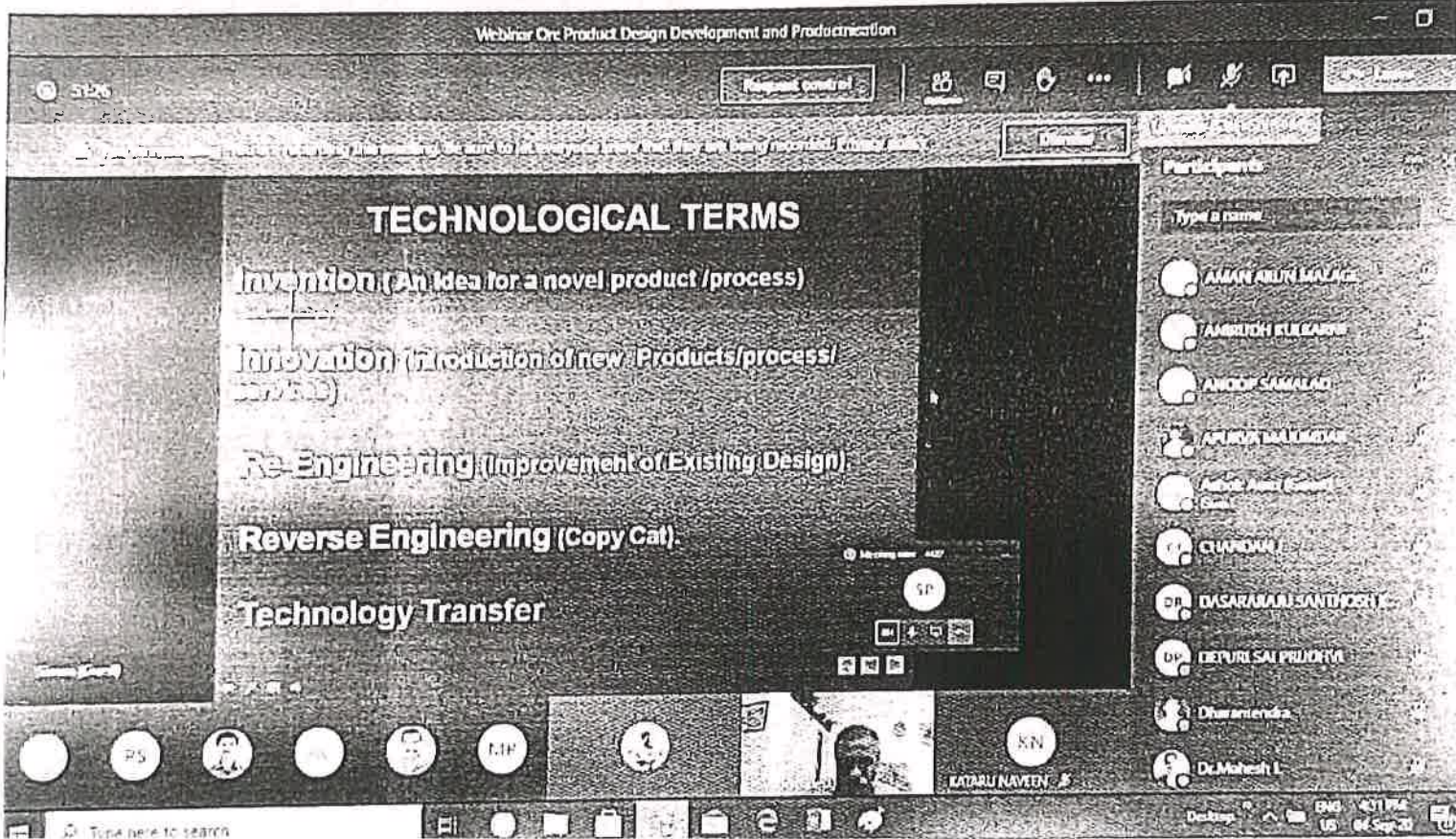
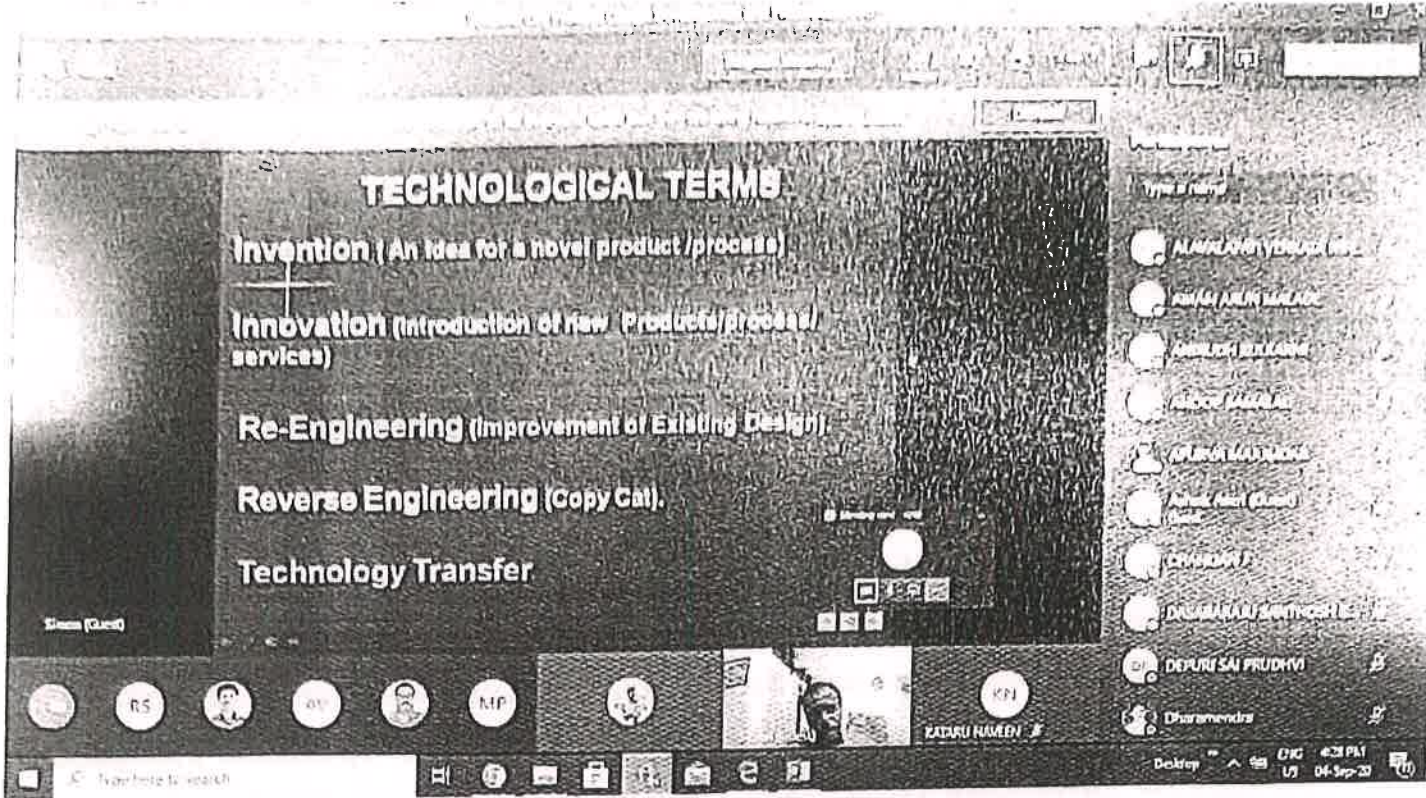



Webinar Orc Product Design Development and Production

5219

Request control

Participants

## DESIGN & DEVELOPMENT STAGES

- \* Idea Conceptualization.
- \* Feasibility Study.
- \* Preliminary Design stage.
- \* Detailed Design & Development stage.
- \* Prototype Testing Stages.
- \* Refinement Stages.
- \* Limited Operation Stages.

Simon (Guest)

Participants list:

- ABHISHEK...
- ABHISHEK...
- AKSHAY GHOSH
- AKSHAY JI
- ALAKAPANI VENKATA...
- AMAN ARUN BALAGE
- ANIRUDH KULKARNI
- APURVA MAJUMDAR
- Ashok Asari (Guest)
- DASARARAJU SANTHOSH K...

Simon (Guest) | RS | AV | MP | SUMAN S | KATARU NAVLEEN

Type here to search

Desktop 4:34 PM 04 Sep 20

Webinar Orc Product Design Development and Production

5219

Request control

Participants

You're recording: You are recording this meeting. Be sure to let everyone know that they are being recorded. Privacy policy

## PRODUCT LIFE CYCLE STAGES

- \* Design, Development & Testing.
- \* Production.
- \* Operational & Maintenance.
- \* Obsolescence Stage.

Simon (Guest)

Participants list:

- AMAN ARUN BALAGE
- ANIRUDH KULKARNI
- ANOOF SAMALAD
- APURVA MAJUMDAR
- Ashok Asari (Guest)
- DASARARAJU SANTHOSH K...
- DEPURU SAI PALLAVU
- Dharmendra
- DUMRANT L
- GAGAN B

Simon (Guest) | RS | AV | MP | SUMAN S | KATARU NAVLEEN

Type here to search

Desktop 4:34 PM 04 Sep 20





Bangalore Branch



**REVA**  
**UNIVERSITY**

Bengaluru, India

We would like to thank our beloved Chancellor, **Dr. P. Shyama Raju** for providing all facilities and support to conduct this program. Also, we thank **Vice Chancellor and Registrar of REVA University** for their continuous support.

We also thank our Director, School of ME, **Dr. K S Narayanaswamy** and **Asst Director, Dr. Mahesh L.** for their constant support and always motivating us to organize such events in School of ME.

We also thank **Dr. Raju B. S** Sir for his continuous support and guidance to organize such webinars.

We also thank all the faculty members of our school and Students for their active participation

*Patil*  
Coordinator 5/9/2020

**Dr. Shanawaz Patil**

*[Signature]*  
5/9/20  
Director

**Dr. K.S. Narayanaswamy**

Director  
School of Mechanical Engineering  
REVA University  
Rukmini Knowledge Park, Kattigenahalli,  
Yelahanka, Bengaluru - 560 064



**REPORT ON INTERCLASS DANCE & MUSIC COMPETITION:  
RANGH MANCH**

**Venue: C K Prahalad Seminar Hall, 7<sup>th</sup> Floor Swami Vivekananda Block**

**Organising Committee: School of Commerce**

**Date: 29.3.2022 & 30.3.2022**

**Conception:**

School of Commerce organised Inter class dance and Music competition: Rangh Manch on 29<sup>th</sup> March and 30<sup>th</sup> March 2022. This event was conducted by Rhythms & Beats Club along with student co-ordinators. The purpose of this competition was to enhance the enthusiasm and creativity of the students and encourage them to participate in extracurricular activities. The competition began with great zest and excitement.

**Objective:**

The aim of the dance major is to develop students who are sensitive and articulate physical and verbal communicators of the visual art of dance; who are proficient in the analysis of dance in its cultural manifestations, leading them beyond knowledge of a culture to an understanding and celebration of difference; and who are flexible, creative thinkers able to perceive, examine and evaluate different points of view.

**Details of the event:**

The programme started at 2.30pm at CK Prahalad Seminar Hall by Welcoming the directors of both School of Commerce and School of Management studies Dr. M Subramanya and Dr. Nitu Ghosh, Judges of the event Prof. Maria, Prof. Jyothi Gupta and Prof. Sunil Kumar, faculty members, participants and our enthusiastic bunch of audience. Ms. Druthi and Ms. Sowmya did the anchoring for the event. There were 14 participants. All the participants were very graceful

and enjoyed whatever they did, judges decided the winners and were asked to address the gathering at the end of the event and also announce the winners.

**The winners of the event were:**

<b>EVENT</b>	<b>PARTICIPANTS</b>	<b>CLASS</b>
Solo Dance	Ananya	IV BCOM A SECTION
Solo Dance	Chiru Deva	IV BBA
Group Dance	Archa and team	
Solo singing	Druthi S	IV BBA



REVA  
UNIVERSITY

Bengaluru, India







REVA  
UNIVERSITY

Bengaluru, India





**REVA**  
**UNIVERSITY**

Bengaluru, India

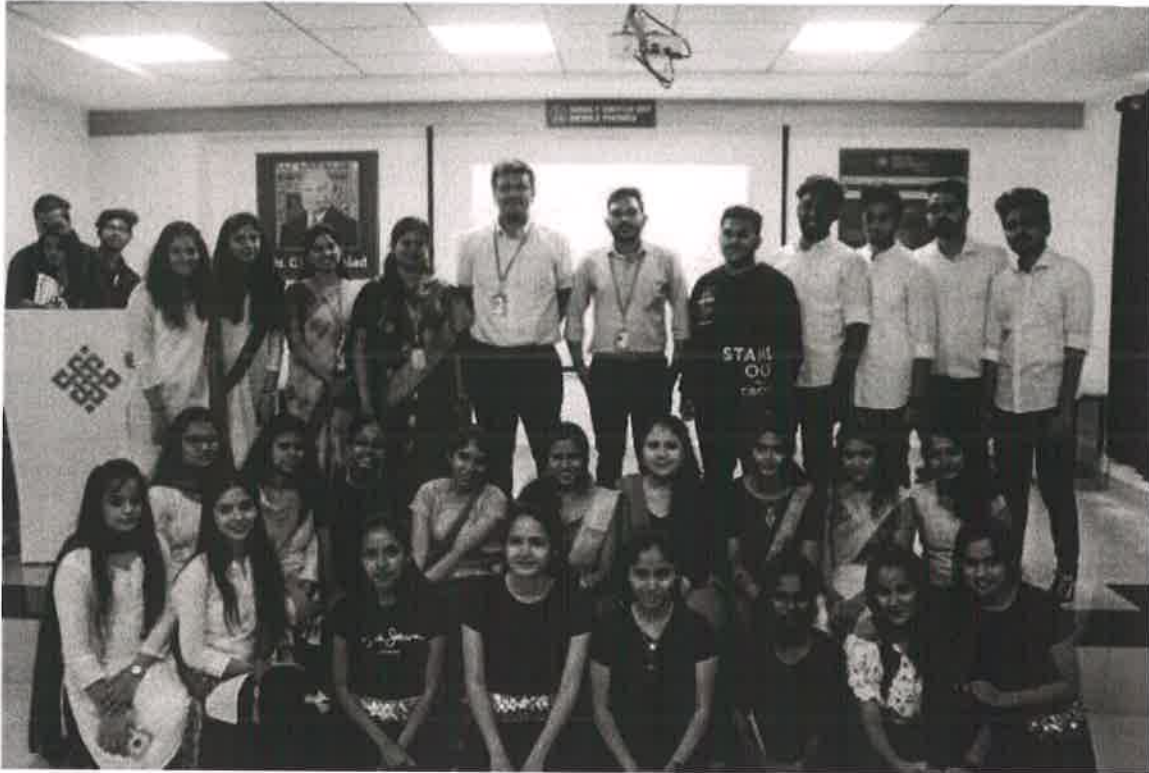

**Director**  
**School of Commerce**  
**REVA University**  
Rukmini Knowledge Park, Kattigenahalli  
Yelahanka, Bengaluru - 560 064

Sl.No	School Name	Club Name	Faculty In-charge	Student In-charge	Established Date
01	School of Performing Arts & Indic Studies	Kala Darshana	Ms. Anjali Raj Urs	NA	20 <sup>th</sup> Jan 2018

### Activities Conducted 2020-21

**Club name: Kala Darshan**

**Date: 17<sup>th</sup> June 2021**

**Number of participants: 12**

**Activity Conducted: Reva Idol- Singing Competition.**

The School of Performing Arts & Indic Studies, REVA University aims to create new platforms in these unprecedented times for artistes who have been deprived of all their conventional forums. We want to create a feeling of solidarity amongst the music fraternity by ensuring that students have alternate avenues to explore and showcase their skills! Ultimately World Music Day is a testament to the resilience of the artistic community that prevails against all odds.... As Napoleon Bonaparte once said Music is the voice that tells us that the human race is greater than it knows....

This year, we at the School of Performing Arts & Indic Studies, are celebrating World Music Day in a grand way with a multi-faceted extravaganza. There is a nationwide music contest called REVA Idol open to all singers 16 years and above. There are also compliments and shout-out videos from eminent artistes like

1. Mahesh Vinayak
2. B K Sumithra
3. Peethambaran
4. Raman Mahadevan
5. Shamanth
6. Rickey Kej
7. Varun Sunil

  
Director  
School of Performing Arts  
REVA University  
Rukmini Knowledge Park, Kattigenahalli  
Yelahanka Bengaluru • 560 084

8. Vivek Rajagopalan

9. Padmini

10. Jyotsna

11. Varun Venkat

12. Dr Suma

**Attendance:** -12

**Photographs:**





189

**REVA**  
**UNIVERSITY**

Bengaluru, India

51

01	<b>School of Performing Arts &amp; Indic Studies</b>	Veekshana	Prof. Sruthy Chandrasekhar	<b>Remya (2020)</b>	<b>21<sup>st</sup> Jan 2019</b>
			Prof. Sruthy Chandrasekhar & <b>Prof. Kumara Datta</b>	<b>Harshavardhan (2021)</b>	

**Club Name: Veekshana**

### Activities Conducted 2022

**Club name:** Veekshana

**Date:** 29<sup>th</sup> April 2022

**Number of participants:** 12

**Activity Conducted:** "Chalana- An outreach Program" on the occasion of World dance day.

The school of Performing Arts and Indic studies brings you "Chalana- An outreach Program" on the occasion of World dance day. The program was held on 29th of April, 2022. Various students from our Department took part in the outreach Program which was held in Shankari Sandya Sadhana-Old-age home, Malleswaram. We performed a variety of art styles, kathak, Ganapathi stotram, Yoga, classical music, folk music, Shiv tandav stotram and a few other performances. It was a delight to perform in front of them who gracefully encouraged us.

The students who took part in this were, Rahul Achari(MPA), Anakha Verma (MPA), Kalamandalam Panchami ( MPA), Devesh Nair (BAPaEP), Rakshith S (BAPaEP), Anindihta (BAPaEP), Jyotsna (BAPaEP), Yash C Agarkhed (BAPaEP), Vasundhra Verma (BAPaEP), Pashupati (Engineering), Avantika Kottisa (BAPaEP) Nithyasree (BAPaEP). Prof. Anand Raj Gonwar Sir and Anjali Rai Ma'am accompanied us there. It was an amazing experience and we thoroughly enjoyed being a part of this. I'd like to sincerely thank the Performing Arts department for giving us this opportunity.

**Attendance:**
**Director**

School of Performing Arts  
 REVA University  
 Rukmini Knowledge Park, Kattigenahalli  
 Yelahanka Bengaluru - 560 064



Sl no.	Names	
1.	Mr. Dhanamjaya madhuraju	Vice chancellor
2.	Dr.N Rmaesh	Registrar
3.	Dr. Vidya Shimladka	Director of School of performing arts
4.	Prof. Akhila	
5.	Yuktha Harish	2 sem BA
6.	Vasundara Verma	1 sem BA
7.	Prof. Sudhanva	
8.	Prof. Ruma Shil	
9.	Professors and students	From various other departments

**Sl. No Names**

1. **Rahul Achari MPA**
2. **Kalamandalam Panchami MPA**
3. **Anakha Verma MPA**
4. **Rakshith S BAPaEP, 4th sem**
5. **Devesh Nair BAPaEP, 4th sem**
6. **Aninditha BAPaEP, 4th sem**
7. **Jyotsna BAPaEP, 4th sem**
8. **Avantika Kottisa BAPaEP, 2nd sem**
9. **Vasundhara Verma BAPaEP, 2nd sem**
10. **Yash C Agarkhed BAPaEP, 2nd sem**



**REVA**  
**UNIVERSITY**

Bengaluru, India

11. Nithyasree BAPaEP, 2nd sem
12. Pashupati Mechanical engineering, 8th sem

**REVA UNIVERSITY**  
Bengaluru, India

School of performing Arts and Indic Studies  
Celebrates **WORLD DANCE DAY 2022**

# Chalana

- Outreach Program by the Students of Performing Arts at Shankari Sandhya Sadana, Malleswaram, Bengaluru
- Seminar on new perspectives on dance

**Chief Guest**  
Dr. Gayathri  
Professor of Sanskrit  
MS Ramiah College of Arts, Science and Commerce

**Moderator**  
Dr. Vidya Kumari S  
Director  
School of Performing Arts & Indic Studies  
REVA University

**Paper Presentations by**

<b>Darshini Manjunath</b> Socio-Cultural Analysis of Dance in Bengaluru During 19th and 20th Century with Special Significance to Bharatanatyam	<b>Sharath T S</b> The Dance of Bengaluru	<b>Sruthy Chandrasekhar</b> Retriving of Men's Saree clothing and Ethnicity of Mysore Region with Special Reference to Karnataka, Madhya Pradesh and Orissa	<b>Swetha Venkatesh</b> Learning Methodology of Bharatanatyam for the Youth
--	--	--	--

**Time : 10:00 am onwards | Venue : School of Performing Arts and Indic Studies**  
[www.reva.edu.in](http://www.reva.edu.in)

**Photographs:**

**Club name:** Veekshana

**Date:** 29/05/22 to 04/06/22

**Number of participants:** 50

**Director**  
School of Performing Arts  
REVA University  
Rukmini Knowledge Park, Kattigenahalli  
Yalahanka Bengaluru - 560 064



## **School of Management studies**

### **Management Club**

#### **A Report for “Best out of Waste” Competition**

The School of management studies, REVA University has organized an “Best out of Waste Competition” for MBA students on 23<sup>th</sup> of March at 2:00 pm onwards. Total 6 teams have registered for this event where in all 6 teams have participated on the day of event between 2:05 to 4:15 pm. Every team has been allowed to use plastic bottle, old newspaper, 2-5 straw, some dry leaves, scissors, gum, stapler, thread etc and any one item of team choice from waste. The teams have shown great creativity and through process to complete the task in 45 minutes.

Every output was judged based on the usefulness, creativity in presenting the object judges, Potential of the product in the market and attractiveness. The students have articulated their thoughts in clear presentation and good delivery. Finally Judges has selected 3 teams to be winner. Students have shared their experiences and told that they have learned about time management, sustainability, recycle and reuse.

The following students have been declared winners in this competition:

1. Prize: Arunima (R20MB184), Arpitha, Kavyashree, Lavanya (MBA 1<sup>st</sup> Sem)

2. Prize:

a) Nithan (R20MB130) and Nanditha. S, Nakul G, Nagalakshmi S. S, MBA 1<sup>st</sup> Sem

b) Muzamil Zia M (R20MB137), Kiran S, Nikhil G A, Lakshmisha

The event was closed with a good note of appreciation from the organizers to the participants.











REVA  
UNIVERSITY

Bengaluru, India



 **REVA**  
UNIVERSITY  
Bengaluru, India  
Established as per the section 201 of the UGC Act, 1956  
Approved by AICTE, COA and BCI, New Delhi

 **ARIIA**  
ASSOCIATION OF INNOVATION INSTITUTIONS  
FOR INNOVATION ACHIEVEMENT

---

School of Management Studies  
Management Club  
Organises Special Lecture on

# Best Out of Waste Competition

**Management Club Faculty Coordinator:**  
Dr. Anshu Rani

Date : 23<sup>rd</sup> March, 2021  
Time : 2:00 P.M.

[www.reva.edu.in](http://www.reva.edu.in)

Organizers,

Dr. Anshu Rani

  
**Dean**  
REVA Business School  
REVA University  
Rukmini Knowledge Park, Kattigenahalli  
Yelahanka, Bengaluru-560 064



**SCHOOL OF MANAGEMENT STUDIES**  
**MANAGEMENT CLUB – “ASK THE EXPERT” SERIES**  
**A REPORT ON**  
**“STRATEGIES FOR EFFECTIVE GROUP DISCUSSION PARTICIPATION”**

**Resource Person:** Mr. Bhanutej Chandrashekar, Lead Learning Consultant, Covance

**Date:** 12<sup>th</sup> January 2021

**Time:** 2.30pm to 4.00pm

**Target Audience:** I Semester MBA Students

**Venue:** 712, 714, 715, 716, Seventh Floor

A session under “*Ask the Expert*” Series was organised by the Management Club @SOM on the topic “Strategies for Effective Group Discussion Participation” on 12<sup>th</sup> January 2021.

The objective of the program was to enable the students to participate in GD effectively. The rationale of the event was to make one aware of the skills that one needs to possess to participate and win over in the group discussions. In an attempt in this direction, the resource person who was invited for the session was Mr. Bhanu who has varied experiences in the field of HR recruitments, training, learning and development and other HR related functionalities.

Mr. Bhanu started the session with what the HR focus on while judging students during their participation in GD. He also focused on the dos and don'ts of the GD and spoke about various mistakes that one tends to make while participating in GD.

He also touched upon those aspects of ones personality that one needs to develop for effective communication during GD participation. He emphasized on how one should take care of ones non verbal communication and body language too while participating.



The session was attended by over 100 students offline and over 100 students online through teams platform. The session was well appreciated by the students who posed several questions to the resource person.

*The following is the testimonial by one of the student, Mr. Anshul, I Sem MBA, A section.*

“Ask The Expert Series” is been a great experience for us, talking about the strategies for effective GD (group discussion) participation. The major and the best thing is that we were getting the information about GROUP DISCUSSION Participation from the past 10year experience of Bhanutej sir.

It was very interactive seminar in which, sir has made us aware about every important point, what to do and what not to do,

Such as from taking initiative in GD to concluding, he mentions every point such as preparing for the best, having a good behavior, effectively listening to other, keeping discussion healthy, making a good work experience, right gesture and proper dressing, taking lead in the discussion, placing your point with respect to other, standing out of the box.

The most interesting thing is that we are getting this information from his past 10year experience.

The conclusion we get is to be confident but not to be over confident and must have a calm and positive behavior and our preparation (home work) should be to very good so one can stand out of the crowd.

Our experience was good and gives us a very positive vibe and its seem that after getting these information students will be able to perform better in Group Discussion.

ANSHUL KUMAR, I SEM MBA, A Section





**Dean**

**REVA Business School**  
**REVA University**  
Rukmini Knowledge Park, Kattigenahalli  
Yelahanka, Bengaluru-560 064  
Bengaluru-560 064



## **School of Management studies**

### **Management Club**

#### **A Report on Poster making and Presentation Competition**

The School of management studies, REVA University has organized an “Poster-making and Presentation Competition” for MBA students on 17<sup>th</sup> of March at 2:00 pm onwards. Total 7 teams have registered for this event where in all 7 teams have participated on the day of event between 2:05 to 3:45 pm. The topic for poster making was : Businesses Post COVID-19. Every poster was judged based on the thought/core idea, creativity in presenting the core idea, neatness and attractiveness of the Poster. The students have articulated their thoughts in clear presentation and good delivery. Finally Judges has selected 2 teams to be winner.

The following students have been declared winners in this competition:

1. Prize: Rahul (R20MB232), Akshata, Sumant and Mery Razia, MBA 1<sup>st</sup> Sem
2. Prize:
  - a) Muzamil.Zia.(R20MB137) and S. Kiran, Nikhil, Lakshmisha, MBA 1<sup>st</sup> Sem
  - b) Arunima (R20MB184), Arpitha, Kavyashree, Lavanya (MBA 1<sup>st</sup> Sem)

The event was closed with a good note of appreciation from the organizers to the participants.





REVA UNIVERSITY  
School of Management Studies

POSTER-MAKING AND PRESENTATION COMPETITION

Judge Name :-

TEAM	Idea	Creativity	Neatness	Attractiveness	Total	Rank
1. Shivanand (R15MB143) 2. Kiran Kumar (R19MB085) 3. Priya chavon (R19MB157) 4. Manasvi (R19MB163)	4	2	4	4	4	(3)
1. B. Saugavnaidu (R20MB187) 2. Soumya (R20MB242) 3. Akshatask (R20MB178) 4. Manjula (R20MB220)	4	3	4	4	14	(3)
1. Aqueeb Khan (R20MB200) 2. Harshita Janani (R20MB120) 3. Chaitra A (R20MB111) 4. Bhavana RH (R20MB105)	3	3	4	4	14	(3)
1. Muzamil Zia (R20MB137) 2. S. Kiran (R20MB131) 3. Nikhil (R20MB140) 4. Lakshmiha (R20MB132)	4	3	5	4	16	(2)
1. Anunima (R20MB184) 2. Anpitha (R20MB183) 3. Kavya Shree (R20MB208) 4. Lavanya (R20MB215)	4	3	4	5	16	(2)

Team	Code/Id	Capacity	Medina	Attendance	Total	Rank
① ✓ 1. Rajeshwar [R20MB278] 2. Kihan M [R20MB270] 3. Kihan T.N [R20MB040] 4. K. Lavankrishna [R20MB094]	4	4	5	5	18	④
② 1. Rahul [R20MB232] 2. Akshata [R20MB177] 3. Sumant. C.N [R20MB246] 4. Mery Razia Gandhi [B2109481485]	2	3	3	3	11	④





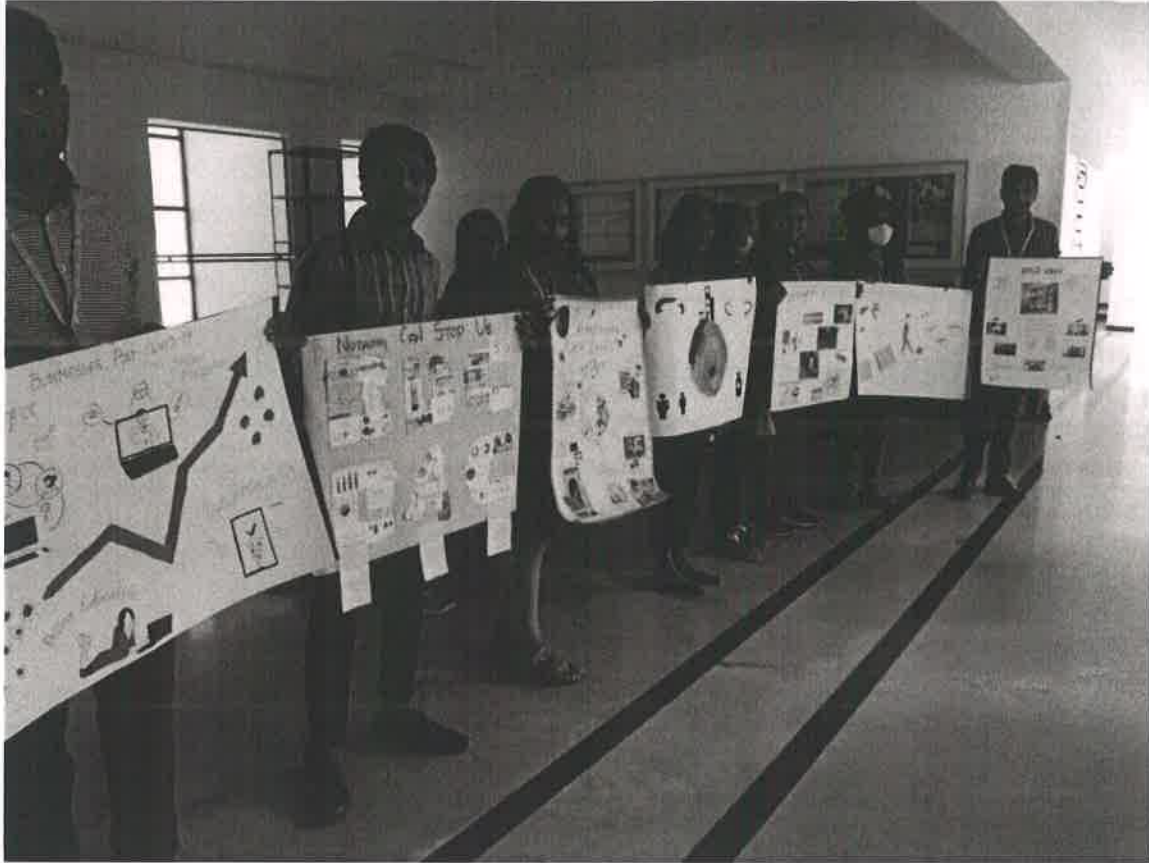









 **REVA**  
UNIVERSITY  
Bengaluru, India  
Established as per the section 201 of the UGC Act, 1956  
Approved by AICTE, COA and DCI, New Delhi

 **ARIA**  
THE ASSOCIATION OF INDEPENDENT AMBA ACCREDITED UNIVERSITIES

---

School of Management Studies  
Management Club  
Presents

**Poster Making and Presentation Competition**

Date: 17<sup>th</sup> March, 2021  
Time: 2.00 P. M

Management Club Faculty Coordinators:  
Dr. Anshu Rani

[www.reva.edu.in](http://www.reva.edu.in)

Organizers,

Dr. Anshu Rani

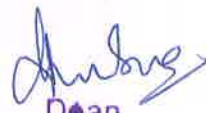
  
Dean  
REVA Business School  
REVA University  
Rukmini Knowledge Park, Kattigenahalli  
Yelahanka, Bengaluru-560 064



## **School of Management studies**

### **Management Club**

#### **A Report on Virtual Elocution Competition**

The School of management studies, REVA University has formed the 'Management club to emphasize the grooming of the student's personality and make them more self-confident to face the real business world. The main purpose of these activities is to make students come up with creative thinking abilities to solve business issues.

The 1<sup>st</sup> activity organized under the club is Virtual Elocution Competition on the topic of "PANDEMIC AND THE LEARNINGS" was conducted on 17<sup>th</sup> Nov 2020. Total 23 teams have registered for this event wherein 14 teams have participated on the day of event between 1:45 to 3:45 pm. The students have articulated their thoughts in clear communication and good delivery. The following students have been declared winners in this competition:

1. Prize: Rakshitha P K (MBA 1<sup>st</sup> Sem)
2. Prize: a) Akhil Varghese Mathew and b) Brundha (MBA 1<sup>st</sup> Sem)
3. Prize: Shruthi R (MBA 1<sup>st</sup> Sem)

The event was closed with a good note of appreciation from the organizers to the participants.

Organizers,

Dr. H N Shylaja

Dr. Anshu Rani







  
**Dean**  
**REVA Business School**  
**REVA University**  
Rukmini Knowledge Park, Kattigenahalli  
Yelahanka, Bengaluru-560 064



**REVA**  
**UNIVERSITY**

Bengaluru, India

**SCHOOL OF MANAGEMENT STUDIES**  
**MANAGEMENT CLUB**

*“ASK THE EXPERTS” Series*

**“CASE ANALYSIS AND PRESENTATION COMPETITION”**

**16<sup>th</sup> of December, 2020, 2.00PM to 3.15PM**

With the foundation provided by Prof. Abhishek Datta Gupta about how one could analyze and present a case, the Management Club@REVA conducted a Case Analysis and Presentation Competition for the first semester MBA Students on 16<sup>th</sup> of December 2020. The competition was conducted virtually from 2.00PM to 3.15PM.

Eight teams registered for the competition and gave presentations about the cases which were shared earlier.

Dr. Ramya, Prof. Shivasharan, Prof. Abhishek, Prof. Maria were the judges for the event who not only judged the events but also guided the students and gave their feed back for improvisation.

The following were the participants of the competition.

Sl. No.	Name of the Participants	Class and Section
1	Anshul Kumar	I Sem A
2	Jwalesh Kumar	I Sem A
3	Brundha S & Harshitha S	I Sem A
4	Kushal Gowda and Prerna	I Sem B
5	Vishal S	I Sem B
6	Vaibhav Gupta	I Sem C
7	Varun	I Sem C

The following participants were declared the winners by the judges:

I Place: Anshul Kumar 21.5 points/25

II Place: Varun 21 points /25

The following are few pictures of the events.



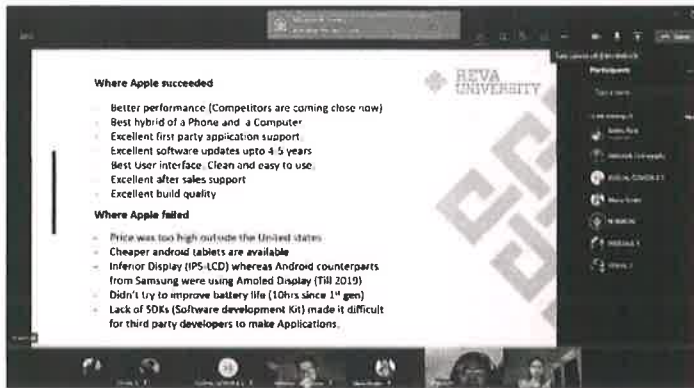

The session ended by thanking the judges who took their time out to guide the students and also the students who participated enthusiastically in the event.

**Management Club Coordinators**

**Dr. Shylaja H N**

**Dr. Anshu Rani**

**Director**

**Dr A Shubha**

**Dean**

**REVA Business School**

**REVA University**

**Rukmini Knowledge Park, Kattigenahalli  
Yelahanka, Bengaluru-560 064**





# REVA UNIVERSITY

Bengaluru, India

Rukmini Knowledge Park, Kattigenahalli  
Yelahanka, Bengaluru - 560 064  
Karnataka, India.

Ph: +91- 90211 90211, +91 80 4696 6966  
E-mail: admissions@reva.edu.in

Follow us on



[www.reva.edu.in](http://www.reva.edu.in)



# REVA UNIVERSITY

Bengaluru, India

Rukmini Knowledge Park, Kattigenahalli  
Yelahanka, Bengaluru - 560 064  
Karnataka, India.

Ph: +91- 90211 90211, +91 80 4696 6966  
E-mail: admissions@reva.edu.in

Follow us on



/REVA University

[www.reva.edu.in](http://www.reva.edu.in)